



HADLER



Preisliste
Pricelist



Luxsystem[®]



Projekt Project: Feuerwache Waiblingen, Zimmermann Architekten, Ludwigsburg

Preisliste Pricelist

Stand: Februar 2023
Edition: February 2023

Impressum Imprint

Herausgeber: HADLER GmbH
Publisher: HADLER GmbH

Technische Änderungen vorbehalten
Technical data subject to change without notice

Drucktechnisch bedingte Farbabweichungen sind möglich
Colour deviations caused by printing technology are possible

©HADLER GmbH · 02/2023

LED-Leuchten und Lichtsteuerung

LED luminaires and Lighting Control Systems

Seite
Page

SL 20.3 LED

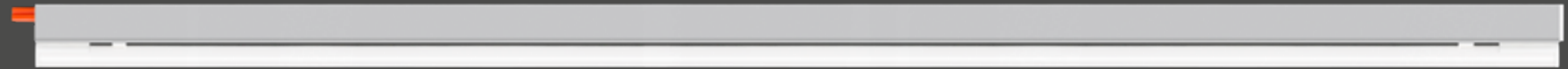

06 – 23

SL 20.2 LED

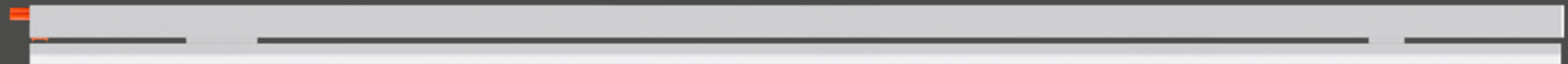

24 – 45

SL 67.2 LED



46 – 52

DALI uP Lichtsteuerung / Zubehör Allgemein
DALI uP Lighting Controller / Accessories

54 – 57

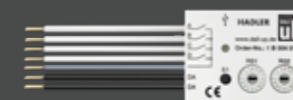



Projekt Project: Axel Arigato Store London Architekt Christian Halleröd design Fotograf Mikael Olsson



SL 20.3 LED

	Seite Page		Seite Page
Lichtband-Aufbauleuchte Startmodul Surface-mounted Linear System Start Module	9	Lichtband-Pendelleuchte Linear Pendant System Module	15
Lichtbandleuchte Linear System Module	10	Einzel-Aufbauleuchte Surface-mounted Single Fitting Luminaire	16
Lichtbandleuchte Endmodul Linear System Module End Module	11	Einzel-Pendelleuchte Single Fitting Pendant Luminaire	17
Lichtband-Aufbauleuchte Surface-mounted Linear Luminaire	12 – 13	Zubehör Accessories	18 – 21
Lichtband-Pendelleuchte Startmodul Linear Pendant System Module Start Module	14	Leuchtmittel SLS LED Lamp SLS LED	22

SL 20.3 LED

Technische Daten
Technical Data

Technische Daten

Technical Data

Lampe Lamp	SLS LED
Netzspannung Input Voltage Range	220 – 240 V, 0/50 – 60 Hz
Temperaturbereich Temperature Range	ta = -40 °C – +40 °C
Lebensdauer Nominal Lifetime	100.000 h @ ta max.
Schutzart IP-Ingress Protection	IP20 (IEC 60529)
Schutzklasse Protection Class	1
Startzeit Start Time	0,6 s (0,3 s DC)
Lichtausbeute Efficacy	160 lm/W *
Notlicht-Niveau Emergency level	50%
Leuchtenkörper Luminaire Housing	Aluminium eloxiert anodized
Notlichttauglich Emergency light suitable	Ja yes
Zeichen Certificates	CE, MM

* Wert kann je nach Leuchtmittel variieren

* This value can vary depending on the lamp

SL 20.3 LED

Lichtband-Aufbauleuchte
Startmodul
Surface-mounted Linear System
Start Module

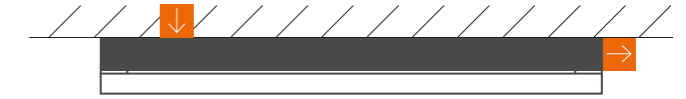

Produktbeschreibung

Schlanke, minimalistische Lichtbandleuchte für schattenfreie Lichtbänder. Anschlussraum für unsichtbare Verdrahtung eingangsseitig, verschiebbare Steckvorrichtung am Ausgang zur schnellen und einfachen Montage weiterer Leuchten.

Product Description

Ultraslim linear start module for seamless continuous runs. A concealed input access slot and Luxsystem sliding plug output connector ensures quick, safe and easy system installation.

⊔	☐	▣	Bestellnr.: Ordercode:	€	⏻	Bestellnr.: Ordercode:	€
885,5	☐	▣	7 O 100 03 6	161,63	⏻	7 O 100 03 0	109,66
885,5	▣	▣	7 O 111 03 6	189,10	⏻	7 O 111 03 0	137,12
885,5	☐	☐	7 O 120 03 6	189,10	⏻	7 O 120 03 0	137,12
1185,5	☐	▣	7 O 200 03 6	167,39	⏻	7 O 200 03 0	115,42
1185,5	▣	▣	7 O 211 03 6	196,27	⏻	7 O 211 03 0	144,29
1185,5	☐	☐	7 O 220 03 6	196,27	⏻	7 O 220 03 0	144,29
1405,5	☐	▣	7 O 300 03 6	173,79	⏻	7 O 300 03 0	121,80
1405,5	▣	▣	7 O 311 03 6	204,23	⏻	7 O 311 03 0	152,26
1405,5	☐	☐	7 O 320 03 6	204,23	⏻	7 O 320 03 0	152,26

⬇ Eingang über Klemmen im Gehäuseboden
(Ausschnitt 17 x 60 mm).

Input via terminals in the bottom of the housing
(access slot 17 x 60 mm).

➡ Ausgang über Luxsystem Steckvorrichtung.
Output via Luxsystem connection system.

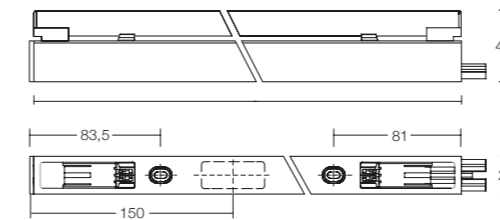

⊔ Länge in mm
Length in mm

☐ Gehäusefarbe Colour luminaire body
▣ Silber / Schwarz / Weiß Silver / Black / White

▣ Farbe Kunststoffteile Colouring of plastic parts
▣ Schwarz / Grau / Weiß Black / Grey / White

⏻ Nicht dimmbar
Not dimmable

☐ Dimmbar DALI
Dimmable DALI

Leuchtmittel ist nicht im Lieferumfang enthalten. Bitte Leuchtmittel separat bestellen! Please note that the light source is to be ordered separately!



SL 20.3 LED Lichtbandleuchte Linear System Module

Produktbeschreibung

Schlanke, minimalistische Lichtbandleuchte für schattenfreie Lichtbänder. Luxsystem Steckvorrichtung eingangs- und ausgangsseitig zur schnellen und einfachen Montage.

Product Description

Ultraslim linear modules for seamless continuous runs. Flexible configuration and very easy to install with ingenious Luxsystem connector system.

-  Eingang über Luxsystem Steckvorrichtung.
Input via Luxsystem connection system.
-  Ausgang über Luxsystem Steckvorrichtung.
Output via Luxsystem connection system.

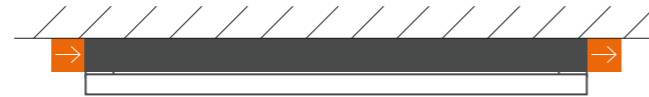
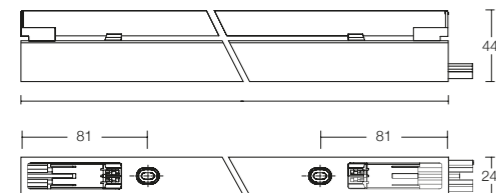

H	☐	■	Bestellnr.: Ordercode:	€	⏻	Bestellnr.: Ordercode:	€
583	☐	■	7 O 000 00 6	156,27	⏻	7 O 000 00 0	104,29
583	■	■	7 O 011 00 6	182,32	⏻	7 O 011 00 0	130,33
583	☐	☐	7 O 020 00 6	182,32	⏻	7 O 020 00 0	130,33
883	☐	☐	7 O 100 00 6	161,63	⏻	7 O 100 00 0	109,66
883	■	■	7 O 111 00 6	189,10	⏻	7 O 111 00 0	137,12
883	☐	☐	7 O 120 00 6	189,10	⏻	7 O 120 00 0	137,12
1183	☐	☐	7 O 200 00 6	167,39	⏻	7 O 200 00 0	115,42
1183	■	■	7 O 211 00 6	196,27	⏻	7 O 211 00 0	144,29
1183	☐	☐	7 O 220 00 6	196,27	⏻	7 O 220 00 0	144,29
1403	☐	☐	7 O 300 00 6	173,79	⏻	7 O 300 00 0	121,80
1403	■	■	7 O 311 00 6	204,23	⏻	7 O 311 00 0	152,26
1403	☐	☐	7 O 320 00 6	204,23	⏻	7 O 320 00 0	152,26

SL 20.3 LED Lichtbandleuchte Endmodul Linear Module System End Module

Produktbeschreibung

Schlanke, minimalistische Lichtbandleuchte für schattenfreie Lichtbänder. Steckvorrichtung eingangsseitig und Abschlusskappe ausgangsseitig zur sicheren und einfachen Montage, auch als Einzelleuchte mit separater Anschlussleitung.

Product Description

Ultraslim linear module for terminating seamless continuous runs or alternatively can be used as a single fitting. Luxsystem plug input connector ensures quick, safe, and easy installation. Single fitting luminaires require an accessory cable plug.

-  Eingang über Luxsystem Steckvorrichtung.
Input via luxsystem connection system.

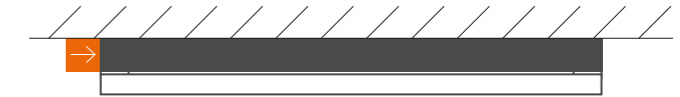
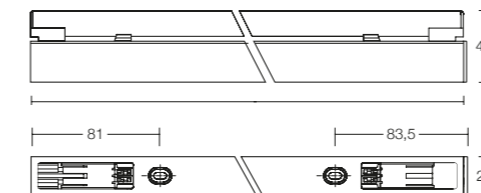

H	☐	■ <th>Bestellnr.: Ordercode:</th> <th>€</th> <th>⏻</th> <th>Bestellnr.: Ordercode:</th> <th>€</th>	Bestellnr.: Ordercode:	€	⏻	Bestellnr.: Ordercode:	€
585,5	☐	■	7 O 000 04 6	156,27	⏻	7 O 000 04 0	104,29
585,5	■	■	7 O 011 04 6	182,32	⏻	7 O 011 04 0	130,33
585,5	☐	☐	7 O 020 04 6	182,32	⏻	7 O 020 04 0	130,33
885,5	☐	☐	7 O 100 04 6	161,63	⏻	7 O 100 04 0	109,66
885,5	■	■	7 O 111 04 6	189,10	⏻	7 O 111 04 0	137,12
885,5	☐	☐	7 O 120 04 6	189,10	⏻	7 O 120 04 0	137,12
1185,5	☐	☐	7 O 200 04 6	167,39	⏻	7 O 200 04 0	115,42
1185,5	■	■	7 O 211 04 6	196,27	⏻	7 O 211 04 0	144,28
1185,5	☐	☐	7 O 220 04 6	196,27	⏻	7 O 220 04 0	144,28
1405,5	☐	☐	7 O 300 04 6	173,79	⏻	7 O 300 04 0	121,80
1405,5	■	■	7 O 311 04 6	204,23	⏻	7 O 311 04 0	152,26
1405,5	☐	☐	7 O 320 04 6	204,23	⏻	7 O 320 04 0	152,26

H Länge in mm ☐ Gehäusefarbe Colour luminaire body ■ Farbe Kunststoffteile Colouring of plastic parts ⏻ Nicht dimmbar ☐ Dimmbar DALI
Length in mm Silber/Schwarz/Weiß Silver/Black/White Schwarz/Grau/Weiß Black/Grey/White Not dimmable Dimmable DALI

SL 20.3 LED

Lichtband-Aufbauleuchte

Surface-mounted Linear Luminaire

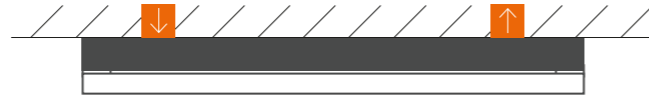

Produktbeschreibung

Schlanke, minimalistische Lichtbandleuchte für schattenfreie Lichtbänder. Anschlussraum für unsichtbare Verdrahtung eingangs- und ausgangsseitig.

Product Description

Ultraslim linear modules for seamless continuous runs. Flexible configuration and easy installation with input and output through concealed access slots.

H	☐	■	Bestellnr.: Ordercode:	€	⏻	Bestellnr.: Ordercode:	€
883	☐	■	7 O 100 07 6	161,63	⏻	7 O 100 07 0	109,66
883	■	■	7 O 111 07 6	189,10	⏻	7 O 111 07 0	137,12
883	☐	☐	7 O 120 07 6	189,10	⏻	7 O 120 07 0	137,12
1183	☐	■	7 O 200 07 6	167,39	⏻	7 O 200 07 0	115,42
1183	■	■	7 O 211 07 6	196,27	⏻	7 O 211 07 0	144,29
1183	☐	☐	7 O 220 07 6	196,27	⏻	7 O 220 07 0	144,29
1403	☐	■	7 O 300 07 6	173,79	⏻	7 O 300 07 0	121,80
1403	■	■	7 O 311 07 6	204,23	⏻	7 O 311 07 0	152,26
1403	☐	☐	7 O 320 07 6	204,23	⏻	7 O 320 07 0	152,26

⏻ Eingang über Klemmen im Gehäuseboden
(zwei Ausschnitte 17 x 60 mm).

Input via terminals in the bottom of luminaire housing
(two individual access slots 17 x 60 mm).

⏻ Ausgang über Klemmen im Gehäuseboden
(zwei Ausschnitte 17 x 60 mm).

Output via terminals in the bottom of luminaire housing
(two individual access slots 17 x 60 mm).

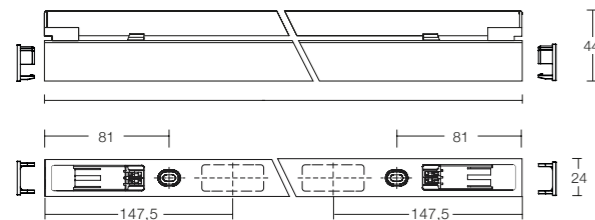

SL 20.3 LED

Lichtband-Aufbauleuchte

Surface-mounted Linear Luminaire

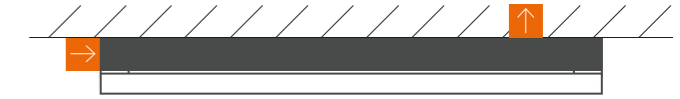

Produktbeschreibung

Schlanke, minimalistische Lichtbandleuchte für schattenfreie Lichtbänder. Steckvorrichtung eingangsseitig zur schnellen und einfachen Montage. Anschlussraum für unsichtbare Verdrahtung ausgangsseitig.

Product Description

Ultraslim linear system end modules. Luxsystem plug connector ensures quick, safe and easy installation and a concealed access slot is included for output flexibility.

H	☐	■	Bestellnr.: Ordercode:	€	⏻	Bestellnr.: Ordercode:	€
585,5	☐	■	7 O 000 02 6	156,27	⏻	7 O 000 02 0	104,29
585,5	■	■	7 O 011 02 6	182,32	⏻	7 O 011 02 0	130,33
585,5	☐	☐	7 O 020 02 6	182,32	⏻	7 O 020 02 0	130,33
885,5	☐	■	7 O 100 02 6	161,63	⏻	7 O 100 02 0	109,66
885,5	■	■	7 O 111 02 6	189,10	⏻	7 O 111 02 0	137,12
885,5	☐	☐	7 O 120 02 6	189,10	⏻	7 O 120 02 0	137,12
1185,5	☐	■	7 O 200 02 6	167,39	⏻	7 O 200 02 0	115,42
1185,5	■	■	7 O 211 02 6	196,27	⏻	7 O 211 02 0	144,29
1185,5	☐	☐	7 O 220 02 6	196,27	⏻	7 O 220 02 0	144,29
1405,5	☐	■	7 O 300 02 6	173,79	⏻	7 O 300 02 0	121,80
1405,5	■	■	7 O 311 02 6	204,23	⏻	7 O 311 02 0	152,26
1405,5	☐	☐	7 O 320 02 6	204,23	⏻	7 O 320 02 0	152,26

➡ Eingang über Luxsystem Steckvorrichtung.
Input via luxsystem connection system.

⏻ Ausgang über Klemmen im Gehäuseboden
(Ausschnitt 17 x 60 mm).

Output via provided terminals in the bottom
of the luminaire housing (access slot 17 x 60 mm).

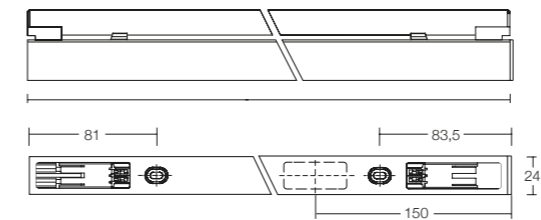

H Länge in mm ☐ Gehäusefarbe ■ Farbe Kunststoffteile ⏻ Nicht dimmbar ☐ Dimmbar DALI
Length in mm Silber/Schwarz/Weiß Silver/Black/White Not dimmable Dimmable DALI

SL 20.3 LED

Lichtband-Pendelleuchte

Startmodul

Linear Pendant System Module

Start Module

Produktbeschreibung

Schlanke, minimalistische Lichtbandleuchte für schattenfreie Lichtbänder. Feste, isolierte und zugentlastete Anschlussleitung für sichere Verdrahtung ein- und ausgangsseitig. Verschiebbare Steckvorrichtung ausgangsseitig zur schnellen und einfachen Montage weiterer Leuchten. Rückseitige Gewinde zur Befestigung der Luxsystem-Pendelvorrichtung (bitte separat bestellen).

Product Description

Ultraslim linear modules for seamless continuous runs with input cable gland incorporating strain relief. Output via ingenious Luxsystem sliding plug connector ensures very quick, easy and safe installation of additional modules. Module has threaded inserts for pendant system. Please note that the pendant system accessories are to be ordered separately.

↓ Eingang über feste Anschlussleitung (3 m) mit Zugentlastung im Gehäuseboden.
Input via cable (3 m) with strain relief in the bottom of the luminaire housing.

Input via cable (3 m) with strain relief in the bottom of the luminaire housing.

→ Ausgang über Luxsystem Steckvorrichtung.
Output via Luxsystem connection system.

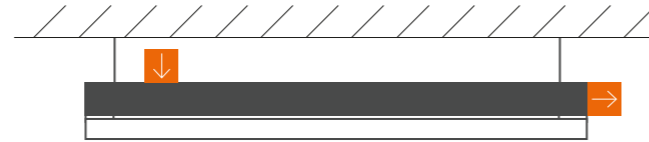
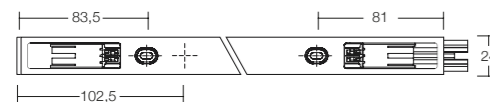
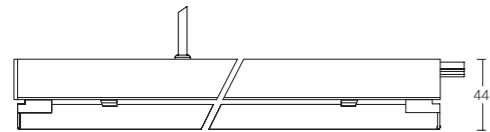

H	☐	■	Bestellnr.: Ordercode:	€	⏻	Bestellnr.: Ordercode:	€
585,5	☐	■	7 O 000 01 6	156,27	⏻	7 O 000 01 0	104,29
585,5	■	■	7 O 011 01 6	182,32	⏻	7 O 011 01 0	130,33
585,5	☐	☐	7 O 020 01 6	182,32	⏻	7 O 020 01 0	130,33
885,5	☐	☐	7 O 100 01 6	161,63	⏻	7 O 100 01 0	109,66
885,5	■	■	7 O 111 01 6	189,10	⏻	7 O 111 01 0	137,12
885,5	☐	☐	7 O 120 01 6	189,10	⏻	7 O 120 01 0	137,12
1185,5	☐	☐	7 O 200 01 6	167,39	⏻	7 O 200 01 0	115,42
1185,5	■	■	7 O 211 01 6	196,27	⏻	7 O 211 01 0	144,29
1185,5	☐	☐	7 O 220 01 6	196,27	⏻	7 O 220 01 0	144,29
1405,5	☐	☐	7 O 300 01 6	173,79	⏻	7 O 300 01 0	121,80
1405,5	■	■	7 O 311 01 6	204,23	⏻	7 O 311 01 0	152,26
1405,5	☐	☐	7 O 320 01 6	204,23	⏻	7 O 320 01 0	152,26

SL 20.3 LED

Lichtband-Pendelleuchte

Linear Pendant System Module

Produktbeschreibung

Schlanke, minimalistische Lichtbandleuchte für schattenfreie Lichtbänder. Luxsystem Steckvorrichtung ein- und ausgangsseitig zur schnellen und einfachen Montage. Rückseitige Gewinde zur Befestigung der Luxsystem-Pendelvorrichtung (bitte separat bestellen).

Product Description

Ultraslim linear modules for seamless continuous runs. Flexible configuration and very easy to install with ingenious Luxsystem connector system. Module has threaded inserts for pendant system. Please note that the pendant system accessories are to be ordered separately.

→ Eingang über Luxsystem Steckvorrichtung.
Input via Luxsystem connection system.

→ Ausgang über Luxsystem Steckvorrichtung.
Output via Luxsystem connection system.

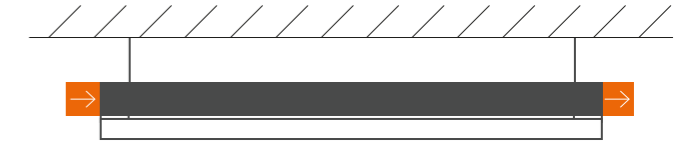

H	☐	■	Bestellnr.: Ordercode:	€	⏻	Bestellnr.: Ordercode:	€
583	☐	■	7 O 000 09 6	156,27	⏻	7 O 000 09 0	104,29
583	■	■	7 O 011 09 6	182,32	⏻	7 O 011 09 0	130,33
583	☐	☐	7 O 020 09 6	182,32	⏻	7 O 020 09 0	130,33
883	☐	☐	7 O 100 09 6	161,63	⏻	7 O 100 09 0	109,66
883	■	■	7 O 111 09 6	189,10	⏻	7 O 111 09 0	137,12
883	☐	☐	7 O 120 09 6	189,10	⏻	7 O 120 09 0	137,12
1183	☐	☐	7 O 200 09 6	167,39	⏻	7 O 200 09 0	115,42
1183	■	■	7 O 211 09 6	196,27	⏻	7 O 211 09 0	144,29
1183	☐	☐	7 O 220 09 6	196,27	⏻	7 O 220 09 0	144,29
1403	☐	☐	7 O 300 09 6	173,79	⏻	7 O 300 09 0	121,80
1403	■	■	7 O 311 09 6	204,23	⏻	7 O 311 09 0	152,26
1403	☐	☐	7 O 320 09 6	204,23	⏻	7 O 320 09 0	152,26

H Länge in mm / Length in mm ☐ Gehäusefarbe / Colour luminaire body ■ Farbe Kunststoffteile / Colouring of plastic parts
 ☐ Silber / Schwarz / Weiß / Silver / Black / White ■ Schwarz / Grau / Weiß / Black / Grey / White

⏻ Nicht dimmbar / Not dimmable

☑ Dimmbar DALI / Dimmable DALI

SL 20.3 LED

Einzel-Aufbauleuchte

Surface-mounted

Single Fitting Luminaire

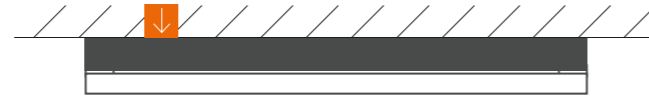

Produktbeschreibung

Schlanke, minimalistische Einzel-Aufbauleuchte. Mit den beidseitigen Endkappen vielseitig sicher und schnell zu montieren.

Product Description

Ultraslim surface-mounted single fitting luminaire. Fully assembled including end caps. A concealed input access slot ensures flexible, quick, safe and easy installation.

⊞	Ⓞ	■	Bestellnr.: Ordercode:	€	Ⓞ	Bestellnr.: Ordercode:	€
588	■	□	7 0 000 06 6	156,27	7 0 000 06 0	104,29	
588	■	■	7 0 011 06 6	182,32	7 0 011 06 0	130,33	
588	□	□	7 0 020 06 6	182,32	7 0 020 06 0	130,33	
888	■	□	7 0 100 06 6	161,63	7 0 100 06 0	109,66	
888	■	■	7 0 111 06 6	189,10	7 0 111 06 0	137,12	
888	□	□	7 0 120 06 6	189,10	7 0 120 06 0	137,12	
1188	■	□	7 0 200 06 6	167,39	7 0 200 06 0	115,42	
1188	■	■	7 0 211 06 6	196,27	7 0 211 06 0	144,29	
1188	□	□	7 0 220 06 6	196,27	7 0 220 06 0	144,29	
1408	■	□	7 0 300 06 6	173,79	7 0 300 06 0	121,80	
1408	■	■	7 0 311 06 6	204,23	7 0 311 06 0	152,26	
1408	□	□	7 0 320 06 6	204,23	7 0 320 06 0	152,26	

⬇ Eingang über Klemmen im Gehäuseboden
(Ausschnitt 17 x 60 mm).

Input via terminals in the bottom of the housing
(access slot 17 x 60 mm).

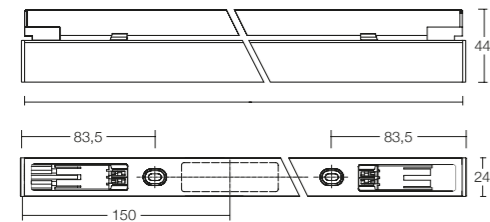

SL 20.3 LED

Einzel-Pendelleuchte

Single Fitting Pendant Luminaire

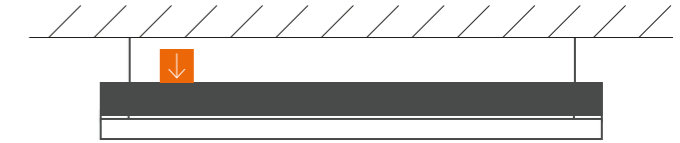

Produktbeschreibung

Schlanke Hängeleuchte in puristischem Design. Mit der höhenverstellbaren Abhängung (Zubehör) können zusätzliche Beleuchtungsaufgaben ohne Systemwechsel gelöst werden (Pendelset bitte separat bestellen).

Product Description

Ultraslim Pendant luminaire in pure minimalist design with adjustable Pendant system (accessories) ensuring quick and flexible installation. Please note that pendant system is to be ordered separately.

⊞	Ⓞ	■	Bestellnr.: Ordercode:	€	Ⓞ	Bestellnr.: Ordercode:	€
588	■	□	7 0 000 08 6	156,27	7 0 000 08 0	104,29	
588	■	■	7 0 011 08 6	182,32	7 0 011 08 0	130,33	
588	□	□	7 0 020 08 6	182,32	7 0 020 08 0	130,33	
888	■	□	7 0 100 08 6	161,63	7 0 100 08 0	109,66	
888	■	■	7 0 111 08 6	189,10	7 0 111 08 0	137,12	
888	□	□	7 0 120 08 6	189,10	7 0 120 08 0	137,12	
1188	■	□	7 0 200 08 6	167,39	7 0 200 08 0	115,42	
1188	■	■	7 0 211 08 6	196,27	7 0 211 08 0	144,29	
1188	□	□	7 0 220 08 6	196,27	7 0 220 08 0	144,29	
1408	■	□	7 0 300 08 6	173,79	7 0 300 08 0	121,80	
1408	■	■	7 0 311 08 6	204,23	7 0 311 08 0	152,26	
1408	□	□	7 0 320 08 6	204,23	7 0 320 08 0	152,26	

⬇ Eingang über feste Anschlussleitung mit Zugentlastung im Gehäuseboden.

Input via cable with strain relief in the bottom of the luminaire housing.

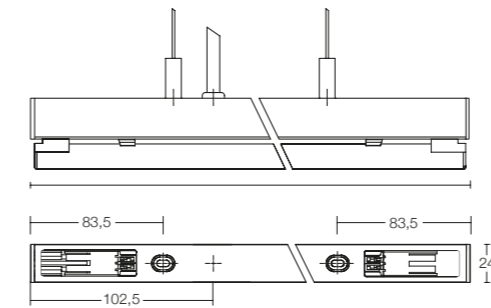

⊞ Länge in mm / Length in mm Ⓞ Gehäusefarbe / Colour luminaire body / Silber / Schwarz / Weiß / Silver / Black / White ■ Farbe Kunststoffteile / Colouring of plastic parts / Schwarz / Grau / Weiß / Black / Grey / White Ⓞ Nicht dimmbar / Not dimmable Ⓞ Dimmbar DALI / Dimmable DALI

SL 20.3 LED

Zubehör

Accessories

Anschlussleitung AL 20

Mains Cable AL 20

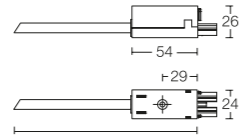

Length	Color	Ordercode	Price (€)	Ordercode	Price (€)
1000	White	5 J 100 51 2	19,09	5 J 100 01 2	15,93
1000	Black	5 J 100 51 0	19,09	5 J 100 01 0	15,93
2000	White	5 J 200 51 2	20,28	5 J 200 01 2	17,11
2000	Black	5 J 200 51 0	20,28	5 J 200 01 0	17,11
5000	White	5 J 500 51 2	25,42	5 J 500 01 2	22,26
5000	Black	5 J 500 51 0	25,42	5 J 500 01 0	22,26

Verbindungsleitung VL 20

Connecting Cable VL 20

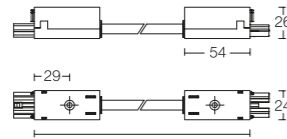

Length	Color	Ordercode	Price (€)	Ordercode	Price (€)
150	White	5 J 015 50 2	23,51	5 J 015 00 2	13,33
150	Black	5 J 015 50 0	23,51	5 J 015 00 0	13,33
200	White	5 J 020 50 2	25,42	5 J 020 00 2	14,41
200	Black	5 J 020 50 0	25,42	5 J 020 00 0	14,41
300	White	5 J 030 50 2	31,13	5 J 030 00 2	26,33
300	Black	5 J 030 50 0	31,13	5 J 030 00 0	26,33
400	White	5 J 040 50 2	31,29	5 J 040 00 2	26,50
400	Black	5 J 040 50 0	31,29	5 J 040 00 0	26,50
600	White	5 J 060 50 2	31,52	5 J 060 00 2	26,78
600	Black	5 J 060 50 0	31,52	5 J 060 00 0	26,78
800	White	5 J 080 50 2	29,60	5 J 080 00 2	26,83
800	Black	5 J 080 50 0	29,60	5 J 080 00 0	26,83
900	White	5 J 090 50 2	31,64	5 J 090 00 2	26,90
900	Black	5 J 090 50 0	31,64	5 J 090 00 0	26,90
1000	White	5 J 100 50 2	31,97	5 J 100 00 2	27,23
1000	Black	5 J 100 50 0	31,97	5 J 100 00 0	27,23
1200	White	5 J 120 50 2	32,20	5 J 120 00 2	26,62
1200	Black	5 J 120 50 0	32,20	5 J 120 00 0	26,62

Längsverbinder, 5-polig

Längsverbinder, 5-Pole

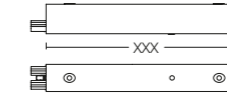

Ordercode	Price (€)
5 P 20 XXX* 1	79,66**
5 P 20 XXX* 2	79,66**
5 P 20 XXX* 3	79,66**

Eckverbinder, 5-polig, rechts

L-Coupler, 5-Pole, Right

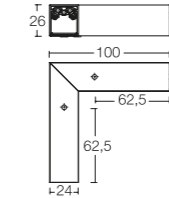

Ordercode	Price (€)
5 P 111 10 1	63,27
5 P 111 10 2	63,27
5 P 111 10 3	63,27

Eckverbinder, 5-polig, links

L-Coupler, 5-Pole, Left

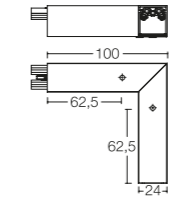

Ordercode	Price (€)
5 P 112 10 1	63,27
5 P 112 10 2	63,27
5 P 112 10 3	63,27

Kreuzverbinder, 5-polig

Cross-Coupler, 5-Pole

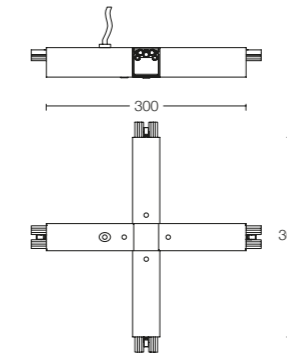

Ordercode	Price (€)
5 P 140 30 1	112,43
5 P 140 30 2	112,43
5 P 140 30 3	112,43

* Erhältlich in den Längen 10 cm bis 160 cm.
Sonderlängen auf Anfrage.
** Preis bei Länge 100 cm.
* Available in 10 cm to 160 cm.
Special lengths on request.
** Price for length 100 cm.

Leuchtmittel SLS LED Light Source SLS LED



Produkteigenschaften

- Abmessungen und Fassungen wie SLS T5
- Abstrahlwinkel über **330°**
- Homogenes Leuchtbild
- Lichtausbeute **>160 lm/W**
- Verschiedene Lichtfarben

Product Applications

- Dimensions and socket coincide with SLS T5 specifications
- Beam Angle > **330°** perfectly matches fluorescent versions
- Homogenous, LED not visible
- Efficacy > **160 lm/W**
- Available in different light temperatures and colours.

Technische Daten Technical Data

Lampe Lamp	SLS LED
Betriebsstrom Rated current	194 mA
Temperaturbereich Temperature Range	ta = -20 °C – +40 °C
Lebensdauer Nominal Lifetime	50.000 h @ ta max. L80B10
Lichtausbeute Efficacy	~160 lm/W*
Halbwertsinkel Rated beam angle (half peak value)	260°
Sockel Socket	G5
Material Material	Glas Glass
Farbkonsistenz Colour consistency	3 SDCM (3-step-McAdam)
Dimmbar Dimmable	Ja Yes
Energieeffizienzklasse Class of Energy Efficiency	A++
Verpackungseinheit Packing Unit Quantities	10
Maß D [mm ±1 mm] Size D [mm±1 mm]	36,00
Maß F [mm ±1 mm] Size F [mm±1 mm]	50,00
Maß G [mm ±1 mm] Size G [mm±1 mm]	8,00
Maß E [mm max.] Size E [mm max.]	16,20

* Wert kann je nach Leuchtmittel variieren * Values can vary depending upon lamp

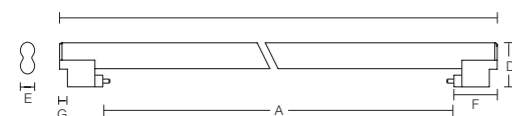

—	CRI	■	Bestellnr.: Ordercode:	€
582 -2	> 80	3000	6 O 169 00 0	71,94
582 -2	> 80	4000	6 O 169 01 0	71,94
882 -2	> 80	3000	6 O 258 10 0	90,81
882 -2	> 80	4000	6 O 258 11 0	90,82
1182 -2	> 80	3000	6 O 347 20 0	100,91
1182 -2	> 80	4000	6 O 347 21 0	100,91
1402 -2	> 80	3000	6 O 410 30 0	107,43
1402 -2	> 80	4000	6 O 410 31 0	107,43
582 -2	> 90	2700	6 O 155 02 1	71,94
582 -2	> 90	3000	6 O 155 00 1	71,94
582 -2	> 90	4000	6 O 155 01 1	71,94
582 -2	> 90	5000	6 O 155 03 1	71,94
582 -2	> 90	6500	6 O 155 04 1	71,94
882 -2	> 90	2700	6 O 237 12 1	90,81
882 -2	> 90	3000	6 O 237 10 1	90,81
882 -2	> 90	4000	6 O 237 11 1	90,81
882 -2	> 90	5000	6 O 237 13 1	90,81
882 -2	> 90	6500	6 O 237 14 1	90,81
1182 -2	> 90	2700	6 O 319 22 1	100,91
1182 -2	> 90	3000	6 O 319 20 1	100,91
1182 -2	> 90	4000	6 O 319 21 1	100,91
1182 -2	> 90	5000	6 O 319 23 1	100,91
1182 -2	> 90	6500	6 O 319 24 1	100,91
1402 -2	> 90	2700	6 O 376 32 1	107,43
1402 -2	> 90	3000	6 O 376 30 1	107,43
1402 -2	> 90	4000	6 O 376 31 1	107,43
1402 -2	> 90	5000	6 O 376 33 1	107,43
1402 -2	> 90	6500	6 O 376 34 1	107,43

— Länge in mm
Length in mm

■ Typische Farbtemperatur in Kelvin
Typical colour temperature in Kelvin



Projekt Project: Feuerwache Waiblingen, Zimmermann Architekten, Ludwigsburg



Projekt Project: Privathaus München
Lichtgestaltung Beckert & Soanca-Pollak, München



SL 20.2 LED

Projekt Project Berlin Hyp, q:arc Architektur | Design Jakubeit & Rapp Partner Architekten mbB, Berlin

	Seite Page		Seite Page
Lichtband-Aufbauleuchte Startmodul Surface-mounted Linear System Start Module	27	Lichtband-Pendelleuchte Linear Pendant System Module	33
Lichtbandleuchte Linear System Module	28	Einzel-Aufbauleuchte Surface-mounted Single Fitting Luminaire	34
Lichtbandleuchte Endmodul Linear System Module End Module	29	Einzel-Pendelleuchte Single Fitting Pendant Luminaire	35
Lichtband-Aufbauleuchte Surface-mounted Linear Luminaire	30 – 31	Zubehör Accessories	36 – 38
Lichtband-Pendelleuchte Startmodul Linear Pendant System Module Start Module	32	Leuchtmittel Light Source	39 – 45

SL 20.2 LED

Technische Daten
Technical Data

Technische Daten Technical Data

Lampe Lamp	SeamLED
Netzspannung Input Voltage Range	220 – 240 V, 0/50 – 60 Hz
Temperaturbereich Temperature Range	ta = -40 °C – +40 °C
Lebensdauer Nominal Lifetime	100.000 h @ ta max.
Schutzart IP-Ingress Protection	IP20 (IEC 60529)
Schutzklasse Protection Class	1
Leuchtenkörper Luminaire Housing	Aluminium, eloxiert Anodized aluminum
Notlichttauglich Emergency light suitable	Ja yes
Zeichen Certificates	CE, MM

SL 20.2 LED

Lichtband-Aufbauleuchte
Startmodul
Surface-mounted Linear System
Start Module

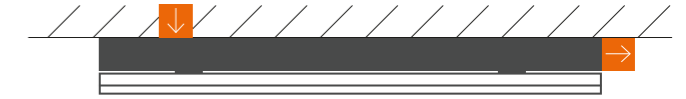



Produktbeschreibung

Schlanke, minimalistische Lichtbandleuchte für schattenfreie Lichtbänder. Anschlussraum für unsichtbare Verdrahtung eingangsseitig, verschiebbare Steckvorrichtung am Ausgang zur schnellen und einfachen Montage weiterer Leuchten.







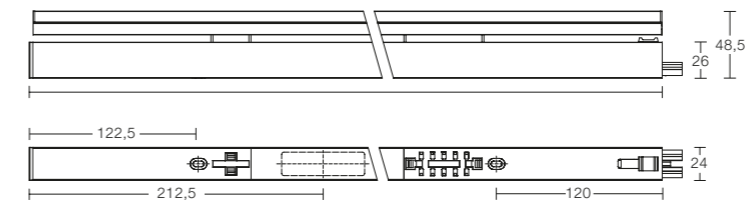











Product Description

Ultraslim linear start module for seamless continuous runs. A concealed input access slot and Luxsystem sliding plug output connector ensures quick, safe and easy system installation.

-  Eingang über Klemmen im Gehäuseboden (Ausschnitt 17 x 60 mm).
Input via terminals in the bottom of the housing (access slot 17 x 60 mm).
-  Ausgang über Luxsystem Steckvorrichtung.
Output via Luxsystem connection system.



-  Länge in mm
Length in mm
-  Eloxalfarbe Anodized finish
-  Schwarz / Silber Black / Silver
-  Farbe Kunststoffteile Colouring of plastic parts
-  Schwarz / Grau Black / Grey
-  Dimmbar DALI
Dimmable DALI

—			Bestellnr.: Ordercode:	€
1002,5			7 M 410 13 6	195,42
1002,5			7 M 410 13 7	224,75
1202,5			7 M 410 23 6	202,25
1202,5			7 M 410 23 7	232,54
1402,5			7 M 410 33 6	208,98
1402,5			7 M 410 33 7	240,28
1602,5			7 M 410 43 6	215,65
1602,5			7 M 410 43 7	247,97

SL 20.2 LED

Lichtbandleuchte

Linear System Module

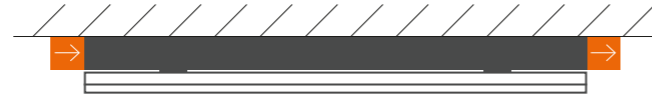



Produktbeschreibung

Schlanke, minimalistische Lichtbandleuchte für schattenfreie Lichtbänder. Luxsystem Steckvorrichtung eingangs- und ausgangsseitig zur schnellen und einfachen Montage.

Product Description

Ultraslim linear modules for seamless continuous runs. Flexible configuration and very easy to install with ingenious Luxsystem connector system.

H	☐	▣	Bestellnr.: Ordercode:	€
800	☐	▣	7 M 410 00 6	188,65
800	▣	▣	7 M 410 00 7	216,94
1000	☐	▣	7 M 410 10 6	195,42
1000	▣	▣	7 M 410 10 7	224,75
1200	☐	▣	7 M 410 20 6	202,25
1200	▣	▣	7 M 410 20 7	232,54
1400	☐	▣	7 M 410 30 6	208,98
1400	▣	▣	7 M 410 30 7	240,28
1600	☐	▣	7 M 410 40 6	215,65
1600	▣	▣	7 M 410 40 7	247,97

-  Eingang über Luxsystem Steckvorrichtung.
Input via Luxsystem connection system.
-  Ausgang über Luxsystem Steckvorrichtung.
Output via Luxsystem connection system.

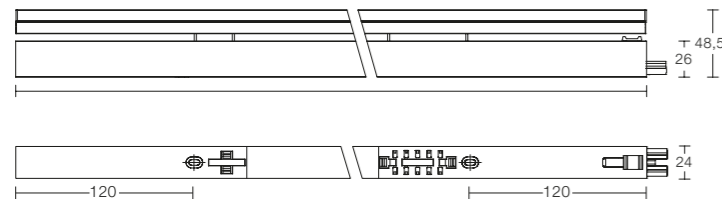

SL 20.2 LED

Lichtbandleuchte

Endmodul

Linear System Module

End Module

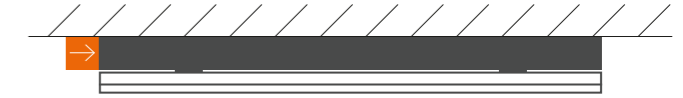

Produktbeschreibung

Schlanke, minimalistische Lichtbandleuchte für schattenfreie Lichtbänder. Steckvorrichtung eingangsseitig und Abschlusskappe ausgangsseitig zur sicheren und einfachen Montage, auch als Einzelleuchte mit separater Anschlussleitung.

Product Description

Ultraslim linear module for terminating seamless continuous runs or alternatively can be used as a single fitting. Luxsystem plug input connector ensures quick, safe and easy installation. Single fitting luminaires require an accessory cable plug.

H	☐	▣	Bestellnr.: Ordercode:	€
802,5	☐	▣	7 M 410 04 6	188,65
802,5	▣	▣	7 M 410 04 7	216,94
1002,5	☐	▣	7 M 410 14 6	195,42
1002,5	▣	▣	7 M 410 14 7	224,75
1202,5	☐	▣	7 M 410 24 6	202,25
1202,5	▣	▣	7 M 410 24 7	232,54
1402,5	☐	▣	7 M 410 34 6	208,98
1402,5	▣	▣	7 M 410 34 7	240,28
1602,5	☐	▣	7 M 410 44 6	215,65
1602,5	▣	▣	7 M 410 44 7	247,97

-  Eingang über Luxsystem Steckvorrichtung.
Input via luxsystem connection system.

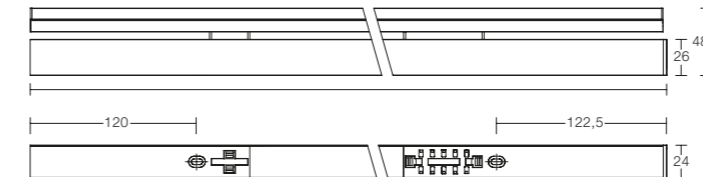

H Länge in mm ☐ Eloxalfarbe Anodized finish ▣ Farbe Kunststoffteile Colouring of plastic parts ☐ Dimmbar DALI
Length in mm ▣ Schwarz / Silber Black / Silver ▣ Schwarz / Grau Black / Grey Dimmable DALI

SL 20.2 LED

Lichtband-Aufbauleuchte

Surface-mounted Linear Luminaire

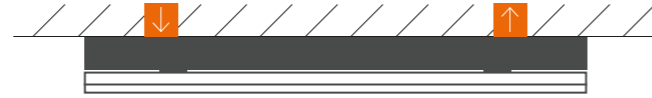

Produktbeschreibung

Schlanke, minimalistische Lichtbandleuchte für schattenfreie Lichtbänder. Anschlussraum für unsichtbare Verdrahtung eingangs- und ausgangsseitig.

Product Description

Ultraslim linear modules for seamless continuous runs. Flexible configuration and easy installation with input and output through concealed access slots.

H	☐	▣	Bestellnr.: Ordercode:	€
1000	☐	▣	7 M 410 17 6	195,42
1000	▣	▣	7 M 410 17 7	224,75
1200	☐	▣	7 M 410 27 6	202,25
1200	▣	▣	7 M 410 27 7	232,54
1400	☐	▣	7 M 410 37 6	208,98
1400	▣	▣	7 M 410 37 7	240,28
1600	☐	▣	7 M 410 47 6	215,65
1600	▣	▣	7 M 410 47 7	247,97

⬇ Eingang über Klemmen im Gehäuseboden
(zwei Ausschnitte 17 x 60 mm).

Input via terminals in the bottom of luminaire housing
(two individual access slots 17 x 60 mm).

⬆ Ausgang über Klemmen im Gehäuseboden
(zwei Ausschnitte 17 x 60 mm).

Output via terminals in the bottom of luminaire housing
(two individual access slots 17 x 60 mm).

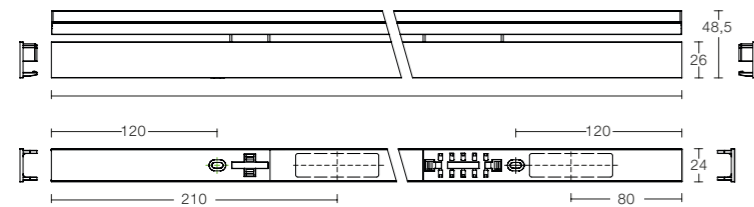

SL 20.2 LED

Lichtband-Aufbauleuchte

Surface-mounted Linear Luminaire

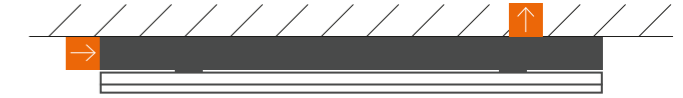

Produktbeschreibung

Schlanke, minimalistische Lichtbandleuchte für schattenfreie Lichtbänder. Steckvorrichtung eingangsseitig zur schnellen und einfachen Montage. Anschlussraum für unsichtbare Verdrahtung ausgangsseitig.

Product Description

Ultraslim linear system end modules. Luxsystem plug connector ensures quick, safe and easy installation and a concealed access slot is included for output flexibility.

H	☐	▣	Bestellnr.: Ordercode:	€
1002,5	☐	▣	7 M 410 12 6	195,42
1002,5	▣	▣	7 M 410 12 7	224,75
1202,5	☐	▣	7 M 410 22 6	202,25
1202,5	▣	▣	7 M 410 22 7	232,54
1402,5	☐	▣	7 M 410 32 6	208,98
1402,5	▣	▣	7 M 410 32 7	240,28
1602,5	☐	▣	7 M 410 42 6	215,65
1602,5	▣	▣	7 M 410 42 7	247,97

➔ Eingang über Luxsystem Steckvorrichtung.
Input via luxsystem connection system.

⬆ Ausgang über Klemmen im Gehäuseboden
(Ausschnitt 17 x 60 mm).

Output via provided terminals in the bottom
of the luminaire housing (access slot 17 x 60 mm).

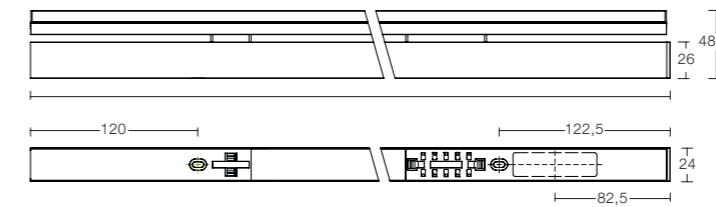

H Länge in mm
Length in mm

☐ Eloxalfarbe Anodized finish
▣ Schwarz / Silber Black / Silver

▣ Farbe Kunststoffteile Colouring of plastic parts
▣ Schwarz / Grau Black / Grey

☐ Dimmbar DALI
Dimmable DALI

SL 20.2 LED

Lichtband-Pendelleuchte

Startmodul

Linear Pendant System Module

Start Module

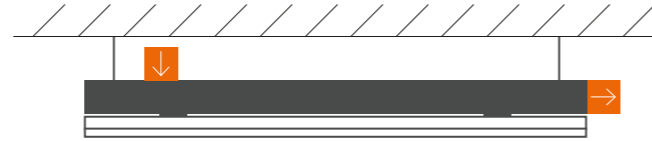

Produktbeschreibung

Schlanke, minimalistische Lichtbandleuchte für schattenfreie Lichtbänder. Feste, isolierte und zugentlastete Anschlussleitung für sichere Verdrahtung ein- und ausgangsseitig. Verschiebbare Steckvorrichtung ausgangsseitig zur schnellen und einfachen Montage weiterer Leuchten. Rückseitige Gewinde zur Befestigung der Luxsystem-Pendelvorrichtung (bitte separat bestellen).

Product Description

Ultraslim linear modules for seamless continuous runs with input cable gland incorporating strain relief. Output via ingenious Luxsystem sliding plug connector ensures very quick, easy and safe installation of additional modules. Module has threaded inserts for pendant system. Please note that the pendant system accessories are to be ordered separately.

↓ Eingang über feste Anschlussleitung (3 m) mit Zugentlastung im Gehäuseboden.

Input via cable (3 m) with strain relief in the bottom of the luminaire housing.

→ Ausgang über Luxsystem Steckvorrichtung.

Output via Luxsystem connection system.

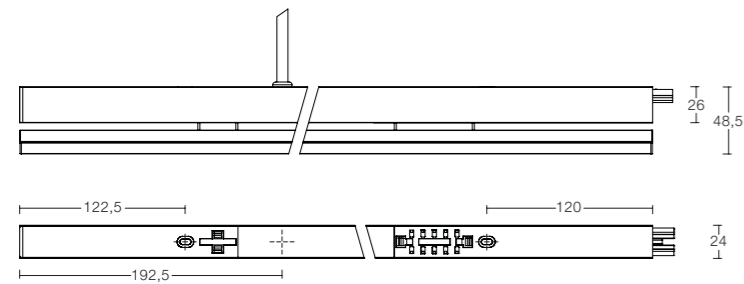

—	☐	▣	Bestellnr.: Ordercode:	€
1002,5	☐	▣	7 M 410 11 6	195,42
1002,5	▣	▣	7 M 410 11 7	224,75
1202,5	☐	▣	7 M 410 21 6	202,25
1202,5	▣	▣	7 M 410 21 7	232,54
1402,5	☐	▣	7 M 410 31 6	208,98
1402,5	▣	▣	7 M 410 31 7	240,28
1602,5	☐	▣	7 M 410 41 6	215,65
1602,5	▣	▣	7 M 410 41 7	247,97

SL 20.2 LED

Lichtband-Pendelleuchte

Linear Pendant System Module

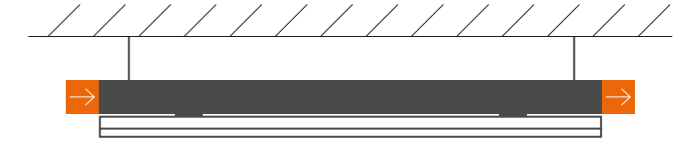

Produktbeschreibung

Schlanke, minimalistische Lichtbandleuchte für schattenfreie Lichtbänder. Luxsystem Steckvorrichtung ein- und ausgangsseitig zur schnellen und einfachen Montage. Rückseitige Gewinde zur Befestigung der Luxsystem-Pendelvorrichtung (bitte separat bestellen).

Product Description

Ultraslim linear modules for seamless continuous runs. Flexible configuration and very easy to install with ingenious Luxsystem connector system. Module has threaded inserts for pendant system. Please note that the pendant system accessories are to be ordered separately.

→ Eingang über Luxsystem Steckvorrichtung.
Input via Luxsystem connection system.

→ Ausgang über Luxsystem Steckvorrichtung.
Output via Luxsystem connection system.

—	☐	▣	Bestellnr.: Ordercode:	€
800	☐	▣	7 M 410 09 6	188,65
800	▣	▣	7 M 410 09 7	216,94
1000	☐	▣	7 M 410 19 6	195,42
1000	▣	▣	7 M 410 19 7	224,75
1200	☐	▣	7 M 410 29 6	202,25
1200	▣	▣	7 M 410 29 7	232,54
1400	☐	▣	7 M 410 39 6	208,98
1400	▣	▣	7 M 410 39 7	240,28
1600	☐	▣	7 M 410 49 6	215,65
1600	▣	▣	7 M 410 49 7	247,97

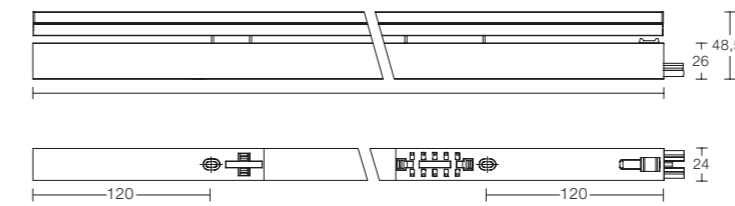

— Länge in mm
Length in mm

☐ Eloxalfarbe Anodized finish
▣ Schwarz / Silber Black / Silver

▣ Farbe Kunststoffteile Colouring of plastic parts
▣ Schwarz / Grau Black / Grey

☐ Dimmbar DALI
Dimmable DALI

SL 20.2 LED

Einzel-Aufbauleuchte

Surface-mounted

Single Fitting Luminaire

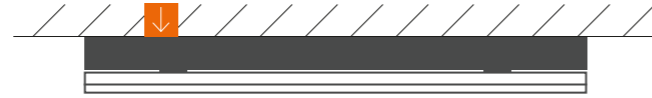

Produktbeschreibung

Schlanke, minimalistische Einzel-Aufbauleuchte. Mit den beidseitigen Endkappen. Anschlussraum für unsichtbare Verdrahtung eingangsseitig.

Product Description

Ultraslim surface-mounted single fitting luminaire. Fully assembled including end caps. A concealed input access slot ensures flexible, quick, safe and easy installation.

H	☐	■	Bestellnr.: Ordercode:	€
1005	☐	■	7 M 410 16 6	195,42
1005	■	■	7 M 410 16 7	224,75
1205	☐	■	7 M 410 26 6	202,25
1205	■	■	7 M 410 26 7	232,54
1405	☐	■	7 M 410 36 6	208,98
1405	■	■	7 M 410 36 7	240,28
1605	☐	■	7 M 410 46 6	215,65
1605	■	■	7 M 410 46 7	247,97

↓ Eingang über Klemmen im Gehäuseboden
(Ausschnitt 17 x 60 mm).

Input via terminals in the bottom of the housing
(access slot 17 x 60 mm).

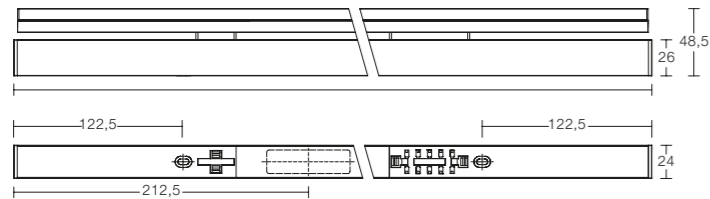

SL 20.2 LED

Einzel-Pendelleuchte

Single Fitting Pendant Luminaire

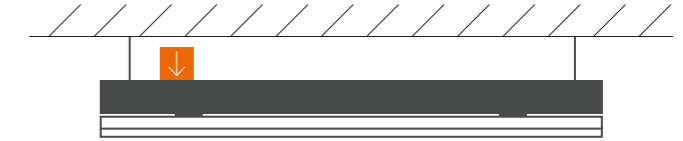

Produktbeschreibung

Schlanke Pendelleuchte in puristischem Design. Mit der höhenverstellbaren Abhängung (Zubehör) können zusätzliche Beleuchtungsaufgaben ohne Systemwechsel gelöst werden (Pendel-Set bitte separat bestellen).

Product Description

Ultraslim Pendant luminaire in pure minimalist design with adjustable Pendant system (accessories) ensuring quick and flexible installation. Please note that pendant system is to be ordered separately.

H	☐	■	Bestellnr.: Ordercode:	€
1005	☐	■	7 M 410 18 6	195,42
1005	■	■	7 M 410 18 7	224,75
1205	☐	■	7 M 410 28 6	202,25
1205	■	■	7 M 410 28 7	232,54
1405	☐	■	7 M 410 38 6	208,98
1405	■	■	7 M 410 38 7	240,28
1605	☐	■	7 M 410 48 6	215,65
1605	■	■	7 M 410 48 7	247,97

↓ Eingang über feste Anschlussleitung mit Zugentlastung
im Gehäuseboden.

Input via cable with strain relief in the bottom of the luminaire housing.

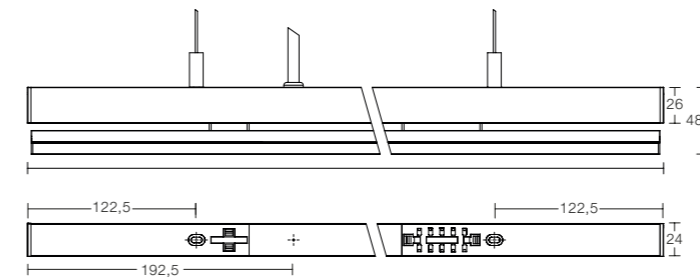

H Länge in mm
Length in mm

☐ Eloxalfarbe Anodized finish
■ Schwarz / Silber Black / Silver

■ Farbe Kunststoffteile Colouring of plastic parts
■ Schwarz / Grau Black / Grey

☐ Dimmbar DALI
Dimmable DALI

SL 20.2 LED Zubehör Accessories

Anschlussleitung AL 20 Mains Cable AL 20

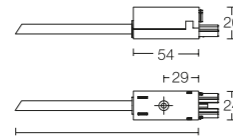

—	☐	■	Bestellnr.: Ordercode:	€
1000	☐		5 J 100 51 2	19,09
1000		■	5 J 100 51 0	19,09
2000	☐		5 J 200 51 2	20,28
2000		■	5 J 200 51 0	20,28
5000	☐		5 J 500 51 2	25,42
5000		■	5 J 500 51 0	25,42

Verbindungsleitung VL 20 Connecting Cable VL 20

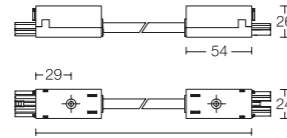

—	☐	■	Bestellnr.: Ordercode:	€
150	☐		5 J 015 50 2	23,51
150		■	5 J 015 50 0	23,51
200	☐		5 J 020 50 2	25,42
200		■	5 J 020 50 0	25,42
300	☐		5 J 030 50 2	31,13
300		■	5 J 030 50 0	31,13
400	☐		5 J 040 50 2	31,29
400		■	5 J 040 50 0	31,29
600	☐		5 J 060 50 2	31,52
600		■	5 J 060 50 0	31,52
800	☐		5 J 080 50 2	31,64
800		■	5 J 080 50 0	31,64
900	☐		5 J 090 50 2	31,64
900		■	5 J 090 50 0	31,64
1000	☐		5 J 100 50 2	31,97
1000		■	5 J 100 50 0	31,97
1200	☐		5 J 120 50 2	32,20
1200		■	5 J 120 50 0	32,20

Leuchtenabhängung Set (2 Stck.) höhenverstell. mit Deckenbefestigung Suspension Set (2 pcs.) Adjustable with Ceiling Fixation

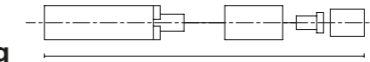

—	Bestellnr.: Ordercode:	€
3000	8 B 000 02 0	28,81

Endabdeckung für Leuchte Luminaire End cap

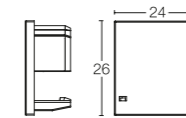

☐	■	Bestellnr.: Ordercode:	€
	■	4 S 00 318	1,30
	■	4 S 00 328	1,30

Längsverbinder, 5-polig Längsverbinder, 5-Pole

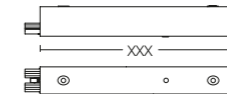

☐	■	Bestellnr.: Ordercode:	€
	■	5 P 30 XXX* 1	79,66**
	■	5 P 30 XXX* 2	79,66**

Eckverbinder, 5-polig, rechts L-Coupler, 5-Pole, Right

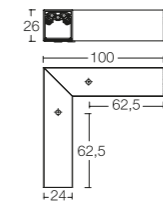

☐	■	Bestellnr.: Ordercode:	€
	■	5 P 111 10 1	63,27
	■	5 P 111 10 2	63,27

Eckverbinder, 5-polig, links L-Coupler, 5-Pole, Left

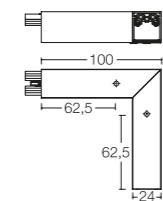

☐	■	Bestellnr.: Ordercode:	€
	■	5 P 112 10 1	63,27
	■	5 P 112 10 2	63,27

* Erhältlich in den Längen 10 cm bis 160 cm.
Sonderlängen auf Anfrage.
** Preis bei Länge 100 cm.
* Available in 10 cm to 160 cm.
Special lengths on request.
** Price for length 100 cm.

— Länge in mm
Length in mm

☐ Eloxalfarbe Anodized finish
■ Schwarz/Silber Black/Silver

☐ Farbe Kunststoffteile Colouring of plastic parts
■ Schwarz/Grau/Weiß Black/Grey/White

☐ Dimmbar DALI
Dimmable DALI

Kreuzverbinder, 5-polig Cross-Coupler, 5-Pole

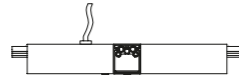

	Bestellnr.: Ordercode:	€
☐	5 P 140 30 1	112,43
■	5 P 140 30 2	112,43

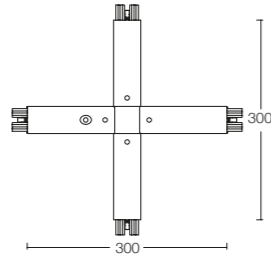

Pendel-Sets Pendelverbinder mit Deckenbefestigung, höhenverstellbar Suspension kits Pendant System with Ceiling Fixation, adjustable

	Bestellnr.: Ordercode:	€	Bestellnr.: Ordercode:	€	Bestellnr.: Ordercode:	€	Bestellnr.: Ordercode:	€
■	8 B 000 23 0	39,55	8 B 000 24 0	45,20	8 B 000 25 0	49,72	8 B 000 26 0	50,85
■	8 B 000 27 0	39,55	8 B 000 28 0	45,20	8 B 000 29 0	49,72	8 B 000 30 0	50,85

Bewegungsmelder-Modul Motion Detector Module

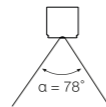
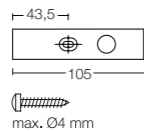

	Bestellnr.: Ordercode:	€
■	7 F 010 01 0	224,85
■	7 F 010 01 1	224,85

Leuchtmittel OPTIC Light Source OPTIC

Name	—	CCT [K]	☐	☑	Bestellnr.: Ordercode:	€
SeamLED R0800	799,5	2700-6500	☐	☑	6 M 208 05 0	289,45
SeamLED R0800	799,5	2700-6500	■	☑	6 M 208 05 2	289,45
SeamLED R1000	999,5	2700-6500	☐	☑	6 M 260 15 0	309,14
SeamLED R1000	999,5	2700-6500	■	☑	6 M 260 15 2	309,14
SeamLED R1200	1199,5	2700-6500	☐	☑	6 M 312 25 0	328,85
SeamLED R1200	1199,5	2700-6500	■	☑	6 M 312 25 2	328,85
SeamLED R1400	1399,5	2700-6500	☐	☑	6 M 364 35 0	348,60
SeamLED R1400	1399,5	2700-6500	■	☑	6 M 364 35 2	348,60
SeamLED R1600	1599,5	2700-6500	☐	☑	6 M 416 45 0	368,29
SeamLED R1600	1599,5	2700-6500	■	☑	6 M 416 45 2	368,29

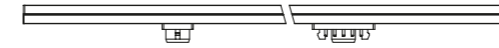

DALI DT8 colour Temperature
CRI = 85

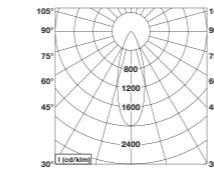

☑ Abdeckung klar
(2.600 lm/m, < 17 W/m)
Cover clear
(2.600 lm/m, < 17 W/m)

— Länge in mm
Length in mm

☐ Eloxalfarbe Anodized finish
■ Schwarz/Silber Black/Silver

☑ Farbe Kunststoffteile Colouring of plastic parts
■ Schwarz/Grau Black/Grey

☑ Abdeckung klar
Cover clear

☑ Diffusor opalisiert
Diffuser opalized

— Pendelverbinder Längs
Pendant System Linear Connector

☐ Pendelverbinder Eck
Pendant System Corner Connectors

⊥ Pendelverbinder T
Pendant System T Connector

+ Pendelverbinder Kreuz
Pendant System X Connector

Leuchtmittel Steady White Light Source Steady White

Name Name	H	CCT [K]	☐	▣	Bestellnr.: Ordercode:	€
SeamLED L0800	799,5	2700	☐	▣	6 M 800 00 0	184,20
SeamLED L0800	799,5	2700	▣	▣	6 M 800 00 1	184,20
SeamLED L0800	799,5	2700	▣	▣	6 M 800 00 2	184,20
SeamLED L0800	799,5	2700	▣	▣	6 M 800 00 3	184,20
SeamLED L0800	799,5	3000	☐	▣	6 M 810 00 0	184,20
SeamLED L0800	799,5	3000	▣	▣	6 M 810 00 1	184,20
SeamLED L0800	799,5	3000	▣	▣	6 M 810 00 2	184,20
SeamLED L0800	799,5	3000	▣	▣	6 M 810 00 3	184,20
SeamLED L0800	799,5	4000	☐	▣	6 M 820 00 0	184,20
SeamLED L0800	799,5	4000	▣	▣	6 M 820 00 1	184,20
SeamLED L0800	799,5	4000	▣	▣	6 M 820 00 2	184,20
SeamLED L0800	799,5	4000	▣	▣	6 M 820 00 3	184,20
SeamLED L0800	799,5	5000	☐	▣	6 M 830 00 0	184,20
SeamLED L0800	799,5	5000	▣	▣	6 M 830 00 1	184,20
SeamLED L0800	799,5	5000	▣	▣	6 M 830 00 2	184,20
SeamLED L0800	799,5	5000	▣	▣	6 M 830 00 3	184,20

Name Name	H	CCT [K]	☐	▣	Bestellnr.: Ordercode:	€
SeamLED L1000	999,5	2700	☐	▣	6 M 800 10 0	196,73
SeamLED L1000	999,5	2700	▣	▣	6 M 800 10 1	196,73
SeamLED L1000	999,5	2700	▣	▣	6 M 800 10 2	196,73
SeamLED L1000	999,5	2700	▣	▣	6 M 800 10 3	196,73
SeamLED L1000	999,5	3000	☐	▣	6 M 810 10 0	196,73
SeamLED L1000	999,5	3000	▣	▣	6 M 810 10 1	196,73
SeamLED L1000	999,5	3000	▣	▣	6 M 810 10 2	196,73
SeamLED L1000	999,5	3000	▣	▣	6 M 810 10 3	196,73
SeamLED L1000	999,5	4000	☐	▣	6 M 820 10 0	196,73
SeamLED L1000	999,5	4000	▣	▣	6 M 820 10 1	196,73
SeamLED L1000	999,5	4000	▣	▣	6 M 820 10 2	196,73
SeamLED L1000	999,5	4000	▣	▣	6 M 820 10 3	196,73
SeamLED L1000	999,5	5000	☐	▣	6 M 830 10 0	196,73
SeamLED L1000	999,5	5000	▣	▣	6 M 830 10 1	196,73
SeamLED L1000	999,5	5000	▣	▣	6 M 830 10 2	196,73
SeamLED L1000	999,5	5000	▣	▣	6 M 830 10 3	196,73
SeamLED L1200	1199,5	2700	☐	▣	6 M 800 20 0	209,27
SeamLED L1200	1199,5	2700	▣	▣	6 M 800 20 1	209,27
SeamLED L1200	1199,5	2700	▣	▣	6 M 800 20 2	209,27
SeamLED L1200	1199,5	2700	▣	▣	6 M 800 20 3	209,27
SeamLED L1200	1199,5	3000	☐	▣	6 M 810 20 0	209,27
SeamLED L1200	1199,5	3000	▣	▣	6 M 810 20 1	209,27
SeamLED L1200	1199,5	3000	▣	▣	6 M 810 20 2	209,27
SeamLED L1200	1199,5	3000	▣	▣	6 M 810 20 3	209,27
SeamLED L1200	1199,5	4000	☐	▣	6 M 820 20 0	209,27
SeamLED L1200	1199,5	4000	▣	▣	6 M 820 20 1	209,27
SeamLED L1200	1199,5	4000	▣	▣	6 M 820 20 2	209,27
SeamLED L1200	1199,5	4000	▣	▣	6 M 820 20 3	209,27
SeamLED L1200	1199,5	5000	☐	▣	6 M 830 20 0	209,27
SeamLED L1200	1199,5	5000	▣	▣	6 M 830 20 1	209,27
SeamLED L1200	1199,5	5000	▣	▣	6 M 830 20 2	209,27
SeamLED L1200	1199,5	5000	▣	▣	6 M 830 20 3	209,27

Name Name	H	CCT [K]	☐	▣	Bestellnr.: Ordercode:	€
SeamLED L1400	1399,5	2700	☐	▣	6 M 800 30 0	221,84
SeamLED L1400	1399,5	2700	▣	▣	6 M 800 30 1	221,84
SeamLED L1400	1399,5	2700	▣	▣	6 M 800 30 2	221,84
SeamLED L1400	1399,5	2700	▣	▣	6 M 800 30 3	221,84
SeamLED L1400	1399,5	3000	☐	▣	6 M 810 30 0	221,84
SeamLED L1400	1399,5	3000	▣	▣	6 M 810 30 1	221,84
SeamLED L1400	1399,5	3000	▣	▣	6 M 810 30 2	221,84
SeamLED L1400	1399,5	3000	▣	▣	6 M 810 30 3	221,84
SeamLED L1400	1399,5	4000	☐	▣	6 M 820 30 0	221,84
SeamLED L1400	1399,5	4000	▣	▣	6 M 820 30 1	221,84
SeamLED L1400	1399,5	4000	▣	▣	6 M 820 30 2	221,84
SeamLED L1400	1399,5	4000	▣	▣	6 M 820 30 3	221,84
SeamLED L1400	1399,5	5000	☐	▣	6 M 830 30 0	221,84
SeamLED L1400	1399,5	5000	▣	▣	6 M 830 30 1	221,84
SeamLED L1400	1399,5	5000	▣	▣	6 M 830 30 2	221,84
SeamLED L1400	1399,5	5000	▣	▣	6 M 830 30 3	221,84
SeamLED L1600	1599,5	2700	☐	▣	6 M 800 40 0	234,37
SeamLED L1600	1599,5	2700	▣	▣	6 M 800 40 1	234,37
SeamLED L1600	1599,5	2700	▣	▣	6 M 800 40 2	234,37
SeamLED L1600	1599,5	2700	▣	▣	6 M 800 40 3	234,37
SeamLED L1600	1599,5	3000	☐	▣	6 M 810 40 0	234,37
SeamLED L1600	1599,5	3000	▣	▣	6 M 810 40 1	234,37
SeamLED L1600	1599,5	3000	▣	▣	6 M 810 40 2	234,37
SeamLED L1600	1599,5	3000	▣	▣	6 M 810 40 3	234,37
SeamLED L1600	1599,5	4000	☐	▣	6 M 820 40 0	234,37
SeamLED L1600	1599,5	4000	▣	▣	6 M 820 40 1	234,37
SeamLED L1600	1599,5	4000	▣	▣	6 M 820 40 2	234,37
SeamLED L1600	1599,5	4000	▣	▣	6 M 820 40 3	234,37
SeamLED L1600	1599,5	5000	☐	▣	6 M 830 40 0	234,37
SeamLED L1600	1599,5	5000	▣	▣	6 M 830 40 1	234,37
SeamLED L1600	1599,5	5000	▣	▣	6 M 830 40 2	234,37
SeamLED L1600	1599,5	5000	▣	▣	6 M 830 40 3	234,37

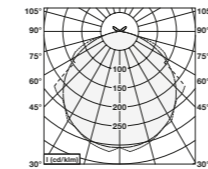

☐ Abdeckung klar
(2.950 lm/m bei 3.000 K, < 18 W/m)
Cover clear
(2.950 lm/m bei 3.000 K, < 18 W/m)

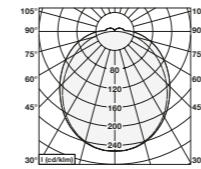

▣ Diffusor opalisiert
(2.450 lm/m bei 3.000 K, < 18 W/m)
Diffuser opalized
(2.450 lm/m bei 3.000 K, < 18 W/m)

H Länge in mm
Length in mm

☐ Eloxalfarbe Anodized finish
▣ Schwarz/Silber Black/Silver

▣ Farbe Kunststoffteile Colouring of plastic parts
▣ Schwarz/Grau Black/Grey

☐ Abdeckung klar
Cover clear

▣ Diffusor opalisiert
Diffuser opalized

Leuchtmittel Steady White HO Light Source Steady White HO

Name Name	H	CCT [K]	☐	▣	Bestellnr.: Ordercode:	€
SeamLED L0800	799,5	2700	▣	▣	6 M 800 01 0	263,13
SeamLED L0800	799,5	2700	▣	▣	6 M 800 01 1	263,13
SeamLED L0800	799,5	2700	▣	▣	6 M 800 01 2	263,13
SeamLED L0800	799,5	2700	▣	▣	6 M 800 01 3	263,13
<hr/>						
SeamLED L0800	799,5	3000	▣	▣	6 M 810 01 0	263,13
SeamLED L0800	799,5	3000	▣	▣	6 M 810 01 1	263,13
SeamLED L0800	799,5	3000	▣	▣	6 M 810 01 2	263,13
SeamLED L0800	799,5	3000	▣	▣	6 M 810 01 3	263,13
<hr/>						
SeamLED L0800	799,5	4000	▣	▣	6 M 820 01 0	263,13
SeamLED L0800	799,5	4000	▣	▣	6 M 820 01 1	263,13
SeamLED L0800	799,5	4000	▣	▣	6 M 820 01 2	263,13
SeamLED L0800	799,5	4000	▣	▣	6 M 820 01 3	263,13
<hr/>						
SeamLED L0800	799,5	5000	▣	▣	6 M 830 01 0	263,13
SeamLED L0800	799,5	5000	▣	▣	6 M 830 01 1	263,13
SeamLED L0800	799,5	5000	▣	▣	6 M 830 01 2	263,13
SeamLED L0800	799,5	5000	▣	▣	6 M 830 01 3	263,13

Name Name	H	CCT [K]	☐	▣	Bestellnr.: Ordercode:	€
SeamLED L1000	999,5	2700	▣	▣	6 M 800 11 0	281,04
SeamLED L1000	999,5	2700	▣	▣	6 M 800 11 1	281,04
SeamLED L1000	999,5	2700	▣	▣	6 M 800 11 2	281,04
SeamLED L1000	999,5	2700	▣	▣	6 M 800 11 3	281,04
<hr/>						
SeamLED L1000	999,5	3000	▣	▣	6 M 810 11 0	281,04
SeamLED L1000	999,5	3000	▣	▣	6 M 810 11 1	281,04
SeamLED L1000	999,5	3000	▣	▣	6 M 810 11 2	281,04
SeamLED L1000	999,5	3000	▣	▣	6 M 810 11 3	281,04
<hr/>						
SeamLED L1000	999,5	4000	▣	▣	6 M 820 11 0	281,04
SeamLED L1000	999,5	4000	▣	▣	6 M 820 11 1	281,04
SeamLED L1000	999,5	4000	▣	▣	6 M 820 11 2	281,04
SeamLED L1000	999,5	4000	▣	▣	6 M 820 11 3	281,04
<hr/>						
SeamLED L1000	999,5	5000	▣	▣	6 M 830 11 0	281,04
SeamLED L1000	999,5	5000	▣	▣	6 M 830 11 1	281,04
SeamLED L1000	999,5	5000	▣	▣	6 M 830 11 2	281,04
SeamLED L1000	999,5	5000	▣	▣	6 M 830 11 3	281,04
<hr/>						
SeamLED L1200	1199,5	2700	▣	▣	6 M 800 21 0	298,95
SeamLED L1200	1199,5	2700	▣	▣	6 M 800 21 1	298,95
SeamLED L1200	1199,5	2700	▣	▣	6 M 800 21 2	298,95
SeamLED L1200	1199,5	2700	▣	▣	6 M 800 21 3	298,95
<hr/>						
SeamLED L1200	1199,5	3000	▣	▣	6 M 810 21 0	298,95
SeamLED L1200	1199,5	3000	▣	▣	6 M 810 21 1	298,95
SeamLED L1200	1199,5	3000	▣	▣	6 M 810 21 2	298,95
SeamLED L1200	1199,5	3000	▣	▣	6 M 810 21 3	298,95
<hr/>						
SeamLED L1200	1199,5	4000	▣	▣	6 M 820 21 0	298,95
SeamLED L1200	1199,5	4000	▣	▣	6 M 820 21 1	298,95
SeamLED L1200	1199,5	4000	▣	▣	6 M 820 21 2	298,95
SeamLED L1200	1199,5	4000	▣	▣	6 M 820 21 3	298,95
<hr/>						
SeamLED L1200	1199,5	5000	▣	▣	6 M 830 21 0	298,95
SeamLED L1200	1199,5	5000	▣	▣	6 M 830 21 1	298,95
SeamLED L1200	1199,5	5000	▣	▣	6 M 830 21 2	298,95
SeamLED L1200	1199,5	5000	▣	▣	6 M 830 21 3	298,95

Name Name	H	CCT [K]	☐	▣	Bestellnr.: Ordercode:	€
SeamLED L1400	1399,5	2700	▣	▣	6 M 800 31 0	316,91
SeamLED L1400	1399,5	2700	▣	▣	6 M 800 31 1	316,91
SeamLED L1400	1399,5	2700	▣	▣	6 M 800 31 2	316,91
SeamLED L1400	1399,5	2700	▣	▣	6 M 800 31 3	316,91
<hr/>						
SeamLED L1400	1399,5	3000	▣	▣	6 M 810 31 0	316,91
SeamLED L1400	1399,5	3000	▣	▣	6 M 810 31 1	316,91
SeamLED L1400	1399,5	3000	▣	▣	6 M 810 31 2	316,91
SeamLED L1400	1399,5	3000	▣	▣	6 M 810 31 3	316,91
<hr/>						
SeamLED L1400	1399,5	4000	▣	▣	6 M 820 31 0	316,91
SeamLED L1400	1399,5	4000	▣	▣	6 M 820 31 1	316,91
SeamLED L1400	1399,5	4000	▣	▣	6 M 820 31 2	316,91
SeamLED L1400	1399,5	4000	▣	▣	6 M 820 31 3	316,91
<hr/>						
SeamLED L1400	1399,5	5000	▣	▣	6 M 830 31 0	316,91
SeamLED L1400	1399,5	5000	▣	▣	6 M 830 31 1	316,91
SeamLED L1400	1399,5	5000	▣	▣	6 M 830 31 2	316,91
SeamLED L1400	1399,5	5000	▣	▣	6 M 830 31 3	316,91
<hr/>						
SeamLED L1600	1599,5	2700	▣	▣	6 M 800 41 0	334,81
SeamLED L1600	1599,5	2700	▣	▣	6 M 800 41 1	334,81
SeamLED L1600	1599,5	2700	▣	▣	6 M 800 41 2	334,81
SeamLED L1600	1599,5	2700	▣	▣	6 M 800 41 3	334,81
<hr/>						
SeamLED L1600	1599,5	3000	▣	▣	6 M 810 41 0	334,81
SeamLED L1600	1599,5	3000	▣	▣	6 M 810 41 1	334,81
SeamLED L1600	1599,5	3000	▣	▣	6 M 810 41 2	334,81
SeamLED L1600	1599,5	3000	▣	▣	6 M 810 41 3	334,81
<hr/>						
SeamLED L1600	1599,5	4000	▣	▣	6 M 820 41 0	334,81
SeamLED L1600	1599,5	4000	▣	▣	6 M 820 41 1	334,81
SeamLED L1600	1599,5	4000	▣	▣	6 M 820 41 2	334,81
SeamLED L1600	1599,5	4000	▣	▣	6 M 820 41 3	334,81
<hr/>						
SeamLED L1600	1599,5	5000	▣	▣	6 M 830 41 0	334,81
SeamLED L1600	1599,5	5000	▣	▣	6 M 830 41 1	334,81
SeamLED L1600	1599,5	5000	▣	▣	6 M 830 41 2	334,81
SeamLED L1600	1599,5	5000	▣	▣	6 M 830 41 3	334,81

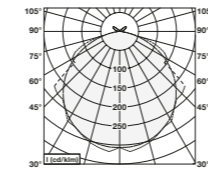

☐ Abdeckung klar
(4.200 lm/m bei 3.000 K, < 25 W/m)
Cover clear
(4.200 lm/m bei 3.000 K, < 25 W/m)

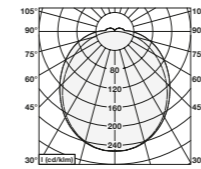

▣ Diffusor opalisiert
(3.500 lm/m bei 3.000 K, < 25 W/m)
Diffuser opalized
(3.500 lm/m bei 3.000 K, < 25 W/m)

H Länge in mm
Length in mm

☐ Eloxalfarbe Anodized finish
▣ Schwarz/Silber Black/Silver

▣ Farbe Kunststoffteile Colouring of plastic parts
▣ Schwarz/Grau Black/Grey

☐ Abdeckung klar
Cover clear

▣ Diffusor opalisiert
Diffuser opalized

Leuchtmittel Tunable White 2.700 – 5.000 K Light Source Tunable White 2,700 – 5,000 K



DALI DT8 colour Temperature
CRI = 85

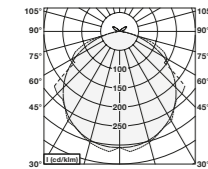

Abdeckung klar
(2.000 lm/m, < 18 W/m)
Cover clear
(2,000 lm/m, < 18 W/m)

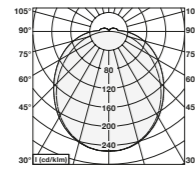

Diffusor opalisiert
(1.680 lm/m, < 18 W/m)
Diffuser opalized
(1,680 lm/m, < 18 W/m)

Name Name	H	C	Bestellnr.: Ordercode:	€
SeamLED A0800	799,5	■ □	6 M 160 00 0	263,13
SeamLED A0800	799,5	■ □	6 M 134 00 1	263,13
SeamLED A0800	799,5	■ □	6 M 160 00 2	263,13
SeamLED A0800	799,5	■ □	6 M 134 00 3	263,13
SeamLED A1000	999,5	■ □	6 M 200 10 0	281,04
SeamLED A1000	999,5	■ □	6 M 168 10 1	281,04
SeamLED A1000	999,5	■ □	6 M 200 10 2	281,04
SeamLED A1000	999,5	■ □	6 M 168 10 3	281,04
SeamLED A1200	1199,5	■ □	6 M 240 20 0	298,95
SeamLED A1200	1199,5	■ □	6 M 201 20 1	298,95
SeamLED A1200	1199,5	■ □	6 M 240 20 2	298,95
SeamLED A1200	1199,5	■ □	6 M 201 20 3	298,95
SeamLED A1400	1399,5	■ □	6 M 280 30 0	316,91
SeamLED A1400	1399,5	■ □	6 M 235 30 1	316,91
SeamLED A1400	1399,5	■ □	6 M 280 30 2	316,91
SeamLED A1400	1399,5	■ □	6 M 235 30 3	316,91
SeamLED A1600	1599,5	■ □	6 M 320 40 0	334,81
SeamLED A1600	1599,5	■ □	6 M 268 40 1	334,81
SeamLED A1600	1599,5	■ □	6 M 320 40 2	334,81
SeamLED A1600	1599,5	■ □	6 M 268 40 3	334,81

Leuchtmittel RGBW Light Source RGBW

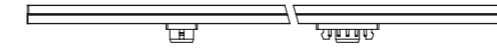

DALI DT8 Primary N
CRI > 93
bei 3.000 - 5.000 K

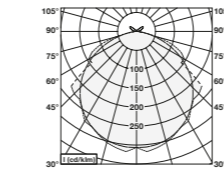

Abdeckung klar
(1.700 lm/m, < 19 W/m)
Cover clear
(1,700 lm/m, < 19 W/m)

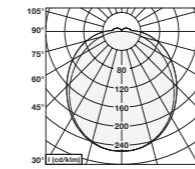

Diffusor opalisiert
(1.430 lm/m, < 19 W/m)
Diffuser opalized
(1,430 lm/m, < 19 W/m)

Name Name	H	E	Bestellnr.: Ordercode:	€
SeamLED G0800	799,5	■ □	6 M 136 02 0	504,51
SeamLED G0800	799,5	■ □	6 M 114 02 1	504,51
SeamLED G0800	799,5	■ □	6 M 136 02 2	504,51
SeamLED G0800	799,5	■ □	6 M 114 02 3	504,51
SeamLED G1000	999,5	■ □	6 M 170 12 0	589,77
SeamLED G1000	999,5	■ □	6 M 143 12 1	589,77
SeamLED G1000	999,5	■ □	6 M 170 12 2	589,77
SeamLED G1000	999,5	■ □	6 M 143 12 3	589,77
SeamLED G1200	1199,5	■ □	6 M 204 22 0	675,02
SeamLED G1200	1199,5	■ □	6 M 172 22 1	675,02
SeamLED G1200	1199,5	■ □	6 M 204 22 2	675,02
SeamLED G1200	1199,5	■ □	6 M 172 22 3	675,02
SeamLED G1400	1399,5	■ □	6 M 238 32 0	760,22
SeamLED G1400	1399,5	■ □	6 M 203 32 1	760,22
SeamLED G1400	1399,5	■ □	6 M 238 32 2	760,22
SeamLED G1400	1399,5	■ □	6 M 203 32 3	760,22
SeamLED G1600	1599,5	■ □	6 M 272 42 0	846,65
SeamLED G1600	1599,5	■ □	6 M 229 42 1	846,65
SeamLED G1600	1599,5	■ □	6 M 272 42 2	846,65
SeamLED G1600	1599,5	■ □	6 M 229 42 3	846,65

H Länge in mm
Length in mm

C Eloxialfarbe Anodized finish
■ Schwarz/Silber Black/Silver

■ Farbe Kunststoffteile Colouring of plastic parts
■ Schwarz/Grau Black/Grey

□ Abdeckung klar
Cover clear

□ Diffusor opalisiert
Diffuser opalized



Bauherr/Builder: HOCHTIEF Projektentwicklung GmbH
Projekt/Project: La Cour

SL 67.2 LED

Seite
Page

Lichtbandleuchte IP 67
Linear System Module IP 67

48

Zubehör
Accessories

50

Leuchtmittel T5 LED
Light Source T5 LED

52

SL 67.2 LED

Lichtbandleuchte IP 67

Linear System Module IP 67

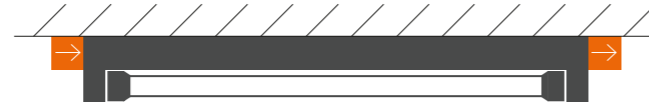



Produktbeschreibung

Schlanke, minimalistische Lichtbandleuchte für schattenarme Lichtbänder in IP 67. Luxsystem Steckvorrichtung eingangs- und ausgangsseitig zur schnellen und einfachen Montage. Montagelöcher zur sicheren Befestigung.

Product Description

Ultra slim high ingress protection rating linear modules for continuous run installations with minimal shadow areas. Ingenious Luxsystem connection system ensures IP 67 integrity at input and output for quick, safe, and easy installation. Mounting holes provided in luminaire housing.

-  Eingang über Luxsystem Steckvorrichtung.
Input via Luxsystem connection system.
-  Ausgang über Luxsystem Steckvorrichtung.
Output via Luxsystem connection system.









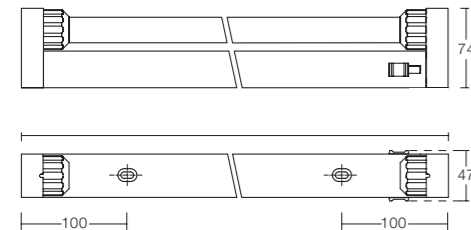

























Technische Daten

Technical Data

Lampe Lamp	T5 LED
Netzspannung Input Voltage Range	220 – 240 V, 0/50 – 60 Hz
Temperaturbereich Temperature Range	ta = -40 °C – +40 °C
Lebensdauer Nominal Lifetime	100.000 h @ ta max.
Schutzart IP-Ingress Protection	IP67 (IEC 60529)
Schutzklasse Protection Class	1
Startzeit Start Time	0,6 s (0,3 s DC)
Lichtausbeute Efficacy	150 lm/W *
Notlicht-Niveau Emergency level	50%
Leuchtenkörper Luminaire Housing	Aluminium, silber eloxiert Anodized aluminum
Zeichen Certificates	CE

* Wert kann je nach Leuchtmittel variieren
* This value can vary depending on the lamp









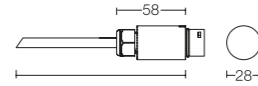

				Bestellnr.: Ordercode:	€	Bestellnr.: Ordercode:	€
599			-	7 P 001 10 6	148,93	7 P 001 10 0	147,91
599			✓	7 P 001 00 6	148,93	7 P 001 00 0	147,91
599			-	7 P 000 10 6	148,93	7 P 000 10 0	147,91
599			✓	7 P 000 00 6	148,93	7 P 000 00 0	147,91
899			-	7 P 101 10 6	159,50	7 P 101 10 0	159,21
899			✓	7 P 101 00 6	159,50	7 P 101 00 0	159,21
899			-	7 P 100 10 6	159,50	7 P 100 10 0	159,21
899			✓	7 P 100 00 6	159,50	7 P 100 00 0	159,21
1199			-	7 P 201 10 6	170,07	7 P 201 10 0	170,51
1199			✓	7 P 201 00 6	170,07	7 P 201 00 0	170,51
1199			-	7 P 200 10 6	170,07	7 P 200 10 0	170,51
1199			✓	7 P 200 00 6	170,07	7 P 200 00 0	170,51
1499			-	7 P 301 10 6	180,64	7 P 301 10 0	181,80
1499			✓	7 P 301 00 6	180,64	7 P 301 00 0	181,80
1499			-	7 P 300 10 6	180,64	7 P 300 10 0	181,80
1499			✓	7 P 300 00 6	180,64	7 P 300 00 0	181,80

-  Länge in mm
Length in mm
-  Eloxalfarbe Anodized finish
 Silber Silver
-  Farbe Kunststoffteile Colouring of plastic parts
 Schwarz / Weiß Black / White
-  Nicht dimmbar
Not dimmable
-  Dimmbar DALI
Dimmable DALI
-  Schutzrohr
Protection tube

Zubehör Accessories









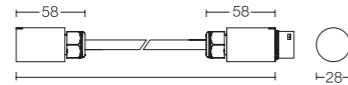



Anschlussleitung AL 30 Mains Cable AL 30



		Bestellnr.: Ordercode:	€		Bestellnr.: Ordercode:	€
1000		5 L 100 51 0	22,82	5 L 100 01 0	17,80	
1000		5 L 100 51 2	22,82	5 L 100 01 2	17,80	
2000		5 L 200 51 0	24,13	5 L 200 01 0	19,09	
2000		5 L 200 51 2	24,13	5 L 200 01 2	19,09	
5000		5 L 500 51 0	26,61	5 L 500 01 0	21,53	
5000		5 L 500 51 2	26,61	5 L 500 01 2	21,53	



Verbindungsleitung VL 30 Connecting Cable VL 30



		Bestellnr.: Ordercode:	€		Bestellnr.: Ordercode:	€
300		5 L 030 50 0	26,61	5 L 030 00 0	22,82	
300		5 L 030 50 2	26,61	5 L 030 00 2	22,82	
600		5 L 060 50 0	26,61	5 L 060 00 0	22,82	
600		5 L 060 50 2	26,61	5 L 060 00 2	22,82	
900		5 L 090 50 0	27,86	5 L 090 00 0	24,13	
900		5 L 090 50 2	27,86	5 L 090 00 2	24,13	
1200		5 L 120 50 0	27,86	5 L 120 00 0	24,13	
1200		5 L 120 50 2	27,86	5 L 120 00 2	24,13	
1500		5 L 150 50 0	27,86	5 L 150 00 0	24,13	
1500		5 L 150 50 2	27,86	5 L 150 00 2	24,13	





Dichtkappe Cover Cap

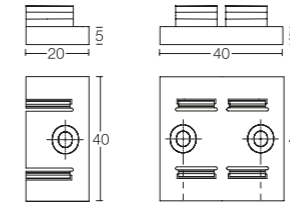

	Bestellnr.: Ordercode:	€
	4 S 00 202	1,30
	4 S 00 222	1,30

Montage-Clip Assembly Clip



	Bestellnr.: Ordercode:	€		Bestellnr.: Ordercode:	€
	4 S 00 214	1,30		4 S 00 215	1,30
	4 S 00 234	1,30		4 S 00 235	1,30

 Einfach
Single

 Doppelt
Double

 Schutzrohr
Protection tube

Leuchtmittel T5 LED

Light Source T5 LED



Produkteigenschaften

- Abmessungen und Sockel wie T5-Leuchtstofflampen
- Abstrahlwinkel über **330°**
- Homogenes Leuchtbild, einzelne LED nicht sichtbar
- Lichtausbeute **160 lm/W**
- Verschiedene Lichtfarben

Product Applications

- Dimensions and socket coincide with T5 fluorescent specifications
- Beam Angle > **330°** perfectly matches fluorescent versions
- Individual LEDs not visible
- Efficacy **160 lm/W**
- Available in different colour temperatures.

Technische Daten

Technical Data

Betriebsstrom Rated Current	195 mA
Temperaturbereich Temperature Range	ta = -20 °C – +60 °C
Lebensdauer Nominal Lifetime	50.000 h ta max. L80B10
Lichtausbeute Efficacy	160 lm/W *
Halbwertswinkel Rated Beam Angle (half peak value)	260°
Sockel Socket	G5
Material Material	Glas Glass
Farbkonsistenz Colour Consistency	3 SDCM (3-step-McAdam)
Dimmbar Dimmable	Ja Yes
Energieeffizienzklasse Class of Energy Efficiency	A++
Verpackungseinheit Packing Unit Quantities	10
Maß E [mm max.] Size E [mm max.]	16,20
Maß tc [mm] Size tc [mm]	75
Isolierung Insulation	330 V

* Wert kann je nach Leuchtmittel variieren * Values can vary depending upon lamp

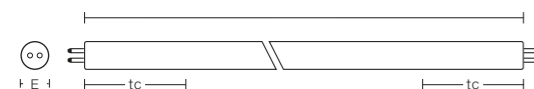

	—	CRI	■	Bestellnr.: Ordercode:	€
549-2	> 80	3000	6 N 143 00 0	37,20	
549-2	> 80	4000	6 N 143 01 0	37,20	
849-2	> 80	3000	6 N 232 10 0	47,04	
849-2	> 80	4000	6 N 232 11 0	47,04	
1149-2	> 80	3000	6 N 321 20 0	57,08	
1149-2	> 80	4000	6 N 321 21 0	57,08	
1449-2	> 80	3000	6 N 410 30 0	67,45	
1449-2	> 80	4000	6 N 410 31 0	67,45	
549-2	> 90	2700	6 N 131 02 1	42,76	
549-2	> 90	3000	6 N 131 00 1	42,76	
549-2	> 90	4000	6 N 131 01 1	42,76	
549-2	> 90	5000	6 N 131 03 1	42,76	
549-2	> 90	6500	6 N 131 04 1	42,76	
849-2	> 90	2700	6 N 213 12 1	54,52	
849-2	> 90	3000	6 N 213 10 1	54,52	
849-2	> 90	4000	6 N 213 11 1	54,52	
849-2	> 90	5000	6 N 213 13 1	54,52	
849-2	> 90	6500	6 N 213 14 1	54,52	
1149-2	> 90	2700	6 N 294 22 1	68,42	
1149-2	> 90	3000	6 N 294 20 1	68,42	
1149-2	> 90	4000	6 N 294 21 1	68,42	
1149-2	> 90	5000	6 N 294 23 1	68,42	
1149-2	> 90	6500	6 N 294 24 1	68,42	
1449-2	> 90	2700	6 N 376 32 1	81,24	
1449-2	> 90	3000	6 N 376 30 1	81,24	
1449-2	> 90	4000	6 N 376 31 1	81,24	
1449-2	> 90	5000	6 N 376 33 1	81,24	
1449-2	> 90	6500	6 N 376 34 1	81,24	

— Länge in mm Length in mm ■ Farbe Kunststoffteile Colouring of plastic parts Einfach Single ■ Typische Farbtemperatur in Kelvin Typical colour temperature in Kelvin Schutzrohr Protection tube Gewicht Weight



DALI uP
Lichtsteuerung
Zubehör Allgemein
Lighting Controller
Accessories

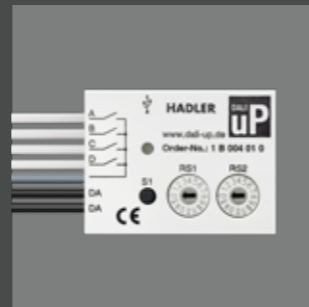

DALI uP
Unter-Putz-Lichtsteuerung
DALI uP
Lighting Control,
Flush Mountable

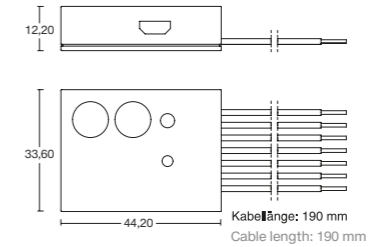

Bestellnr.:
Ordercode: €
1 B 004 01 0 169,49

DALI-Stromversorgung
220 mA, Auf- / Einbau
External Surface Mount
220 mA DALI Power Supply

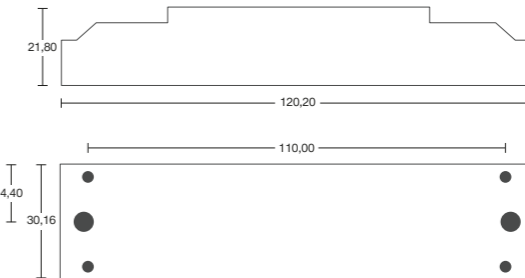

Bestellnr.:
Ordercode: €
9 M 01 104 203,39

DALI-Stromversorgung
200 mA, Hutschienenmontage
200 mA DALI Power Supply
for Top Hat Rail EN 50022

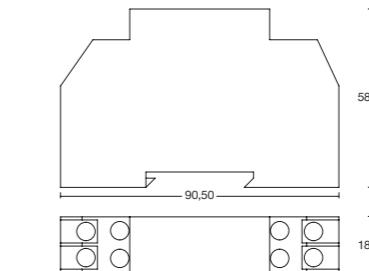

Bestellnr.:
Ordercode: €
9 M 01 101 169,49

DALI-Stromversorgung
240 mA, Standby-Funktion,
Hutschienenmontage
240 mA DALI Power Supply
with standby for Top Hat Rail
EN 50022

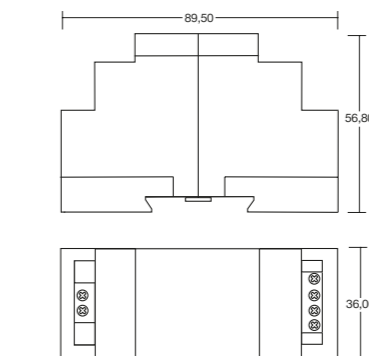

Bestellnr.:
Ordercode: €
9 M 01 103 282,48

Zubehör Allgemein Accessories

EnOcean Modul linear DT 6 EnOcean Module linear DT 6

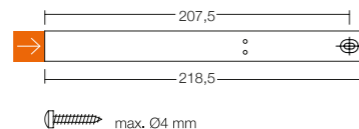

	Bestellnr.:	€
☐	Ordercode:	
■	7 F 000 01 0	333,34
■	7 F 000 01 1	333,34

Produkteigenschaften

EnOcean-DALI-Controller Serie BL-202
Funktion: DALI Broadcast ON/OFF/DIM auf Einfachwippe
230V AC, 868MHz, EVG-Gehäuse

➔ Eingang über Luxsystem Steckvorrichtung.
Input via Luxsystem connection system.

Product Applications

EnOcean-DALI-Controller Series BL-202
Funktion: DALI Broadcast ON/OFF/DIM Single rocker
230V AC, 868MHz, LED driver casing

EnOcean Modul linear DT 8 EnOcean Module linear DT 8

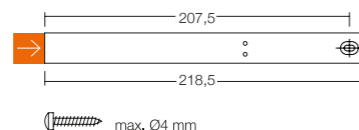

	Bestellnr.:	€
☐	Ordercode:	
■	7 F 000 02 0	337,85
■	7 F 000 02 1	337,85

Produkteigenschaften

EnOcean-DALI-Controller Serie BL-202
Funktion: 1x Tunable white DT8 TC auf Doppelwippe;
Wippe A: ON/OFF/DIM, Wippe B: Farbtemperatur
230V AC, 868 MHz, EVG-Gehäuse

➔ Eingang über Luxsystem Steckvorrichtung.
Input via Luxsystem connection system.

Product Applications

EnOcean-DALI-Controller Series BL-202
Funktion: 1x Tunable white DT8 TC Double rocker;
Rocker A: ON/OFF/DIM, Rocker B: colour temperature
230V AC, 868 MHz, LED driver casing

☐ Eloxalfarbe Anodized finish
■ Schwarz / Silber Black / Silver

EnOcean Modul rund DT 8 EnOcean Module round DT 8

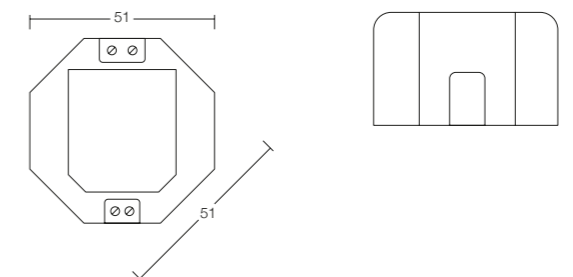

Bestellnr.:	€
Ordercode:	
9 M 01 013	337,85

Produkteigenschaften

EnOcean-DALI-Controller
Funktion: 1x Tunable white DT8 TC auf Doppelwippe;
Wippe A: ON/OFF/DIM, Wippe B: Farbtemperatur
230V AC, 868 MHz, UP-Gehäuse

Product Applications

EnOcean-DALI-Controller
Funktion: 1x Tunable white DT8 TC Double rocker;
Rocker A: ON/OFF/DIM, Rocker B: colour temperature
230V AC, 868 MHz, Flush mountable casing

EnOcean Lichtschalter Einfach- und Doppelwippe, 868 MHz EnOcean Lightswitch Single and double rocker, 868 MHz



Bestellnr.:	€
Ordercode:	
9 M 01 011	145,76

Produkteigenschaften

- Funkübertragung auf Basis von EnOcean, 868 MHz
- Einfachste Montage, auf vorhandener Unterputzdose oder auf glatter Fläche
- Ideale Nachrüstlösung, keine Leitung erforderlich
- Keine Batterien, absolut wartungsfrei
- Kompatibel mit allen Produkten der Serie BL-201 (feste Funktion + FLEX)
- Dem Schalter liegen eine einfache sowie eine doppelte/geteilte Wippe bei, kann je nach Bedarf durch Sie gewechselt/montiert werden

Product Applications

- Radio transmission with EnOcean technology, 868 MHz
- Simple installation, on existing in-wall housing or an even surface
- Ideal retrofitting solution, no wire necessary
- No batteries, absolutely maintenance free
- Compatible with all products from the series BL-201 (fixed functions + FLEX)
- The switch comes with a single and double rocker. It can be changed by you up to your requirements

HADLER GmbH

Fritzlärer Straße 19

34587 Felsberg-Neuenbrunslar

Tel.: +49 5662 9399-0

Fax: +49 5662 9399-29

E-Mail: info@hadler-gmbh.de

www.luxsystem.com

Luxsystem®